

2017

Bohle



Simply Balustrades
Balustrade Hardware Supplies

"Fittings for glass"

Discover the World of Bohle Hardware

The high impact duo for your hardware projects: The Design Manual with its large application images is perfectly suited for choosing the ideal fittings with your customers. The Planning Manual contains all technical data and forms the basis to quickly and easily calculate and implement your projects and orders with Bohle.

You can also find everything online at:
www.bohle-group.com

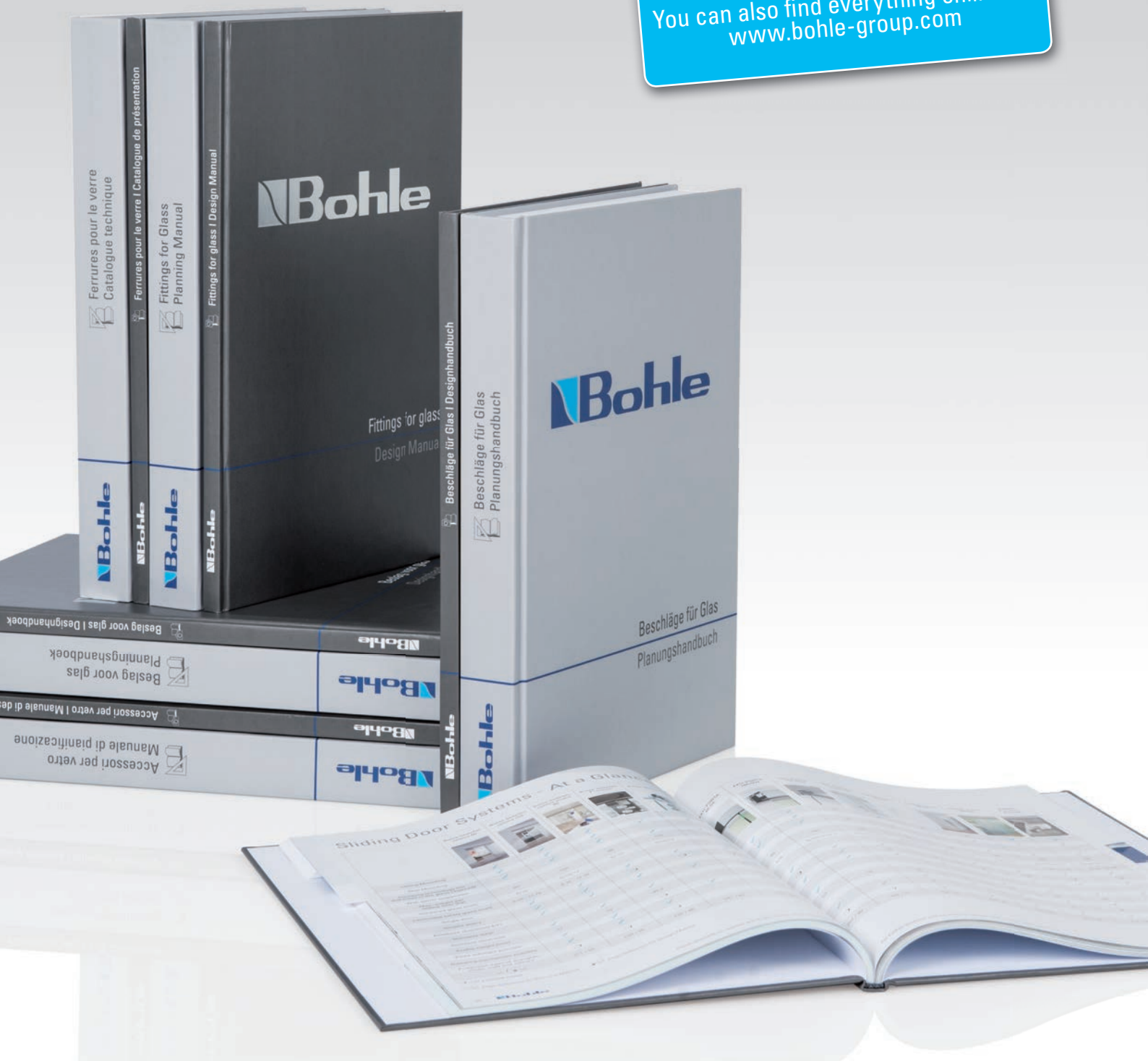

Simply Balustrades ...

Bohle presents a simple overview to our extensive range of balustrade hardware, offering fittings to suit every pocket. Divided into channel systems, clamps, and point fixings, we offer reliable, high quality hardware in a range of price options. This simple guide will offer you options for the construction of most popular balustrade configurations.

To find out more about our comprehensive range please contact our friendly and knowledgeable Customer Services staff, who are more than happy to help you with your enquiries, or visit our website www.bohle-group.com.



EasyMount	4
Posiglaze	12
Clamps	14
Post & Rail System	16
Single Point Fixings	18
How to contact Bohle	23

EasyMount



Slender and Elegant Design

The Bohle EasyMount system enables you to install all-glass railing systems quickly and simply. The stylish system offers high levels of transparency with various application options. The Vario system also gives you the ability to precisely align glass panels.

EasyMount Vario

The EasyMount Vario Glass Mounting Kits enable quick and easy installation. With a simple sliding movement the system can be adjusted by up to 40 mm. The Bohle mounting tool BO 5215281 enables you to work from the accessible side, making installation less time consuming.

To see the full EasyMount range visit our website www.bohle-group.com, or phone 0800 616151 for a full Fittings for Glass catalogue.

EasyMount 6020



EasyMount 6020, 0.74 - 1.5 kN Top Mount



The new EasyMount 6020 profile is the intelligent onward development of Bohle's popular EasyMount Top profile. By increasing the distance between pre-drilled holes, and by allowing the use of anchor bolts without a countersunk head, installation of the new 6020 profile is both faster and much more cost effective.

For use in interior or exterior applications, it can withstand line loads of up to 1.5kN. Glass mounting kits are available from 12mm up to 21.52mm.

Slimline, elegant and low maintenance

- Drainage holes built into profile, or add spacers underneath
- Less fixings required to achieve 0.74kN (mounting distances approx. 200mm centres)
- For glass thickness between 12mm - 21.52mm

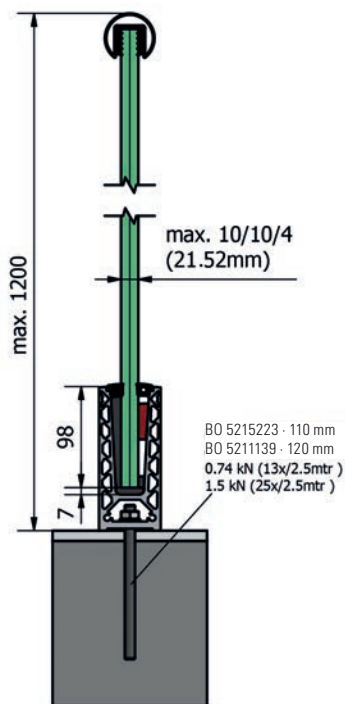

Art.-No.	Length · Material
BO 6060202	2500 mm · Aluminium
BO 6060205	5000 mm · Aluminium

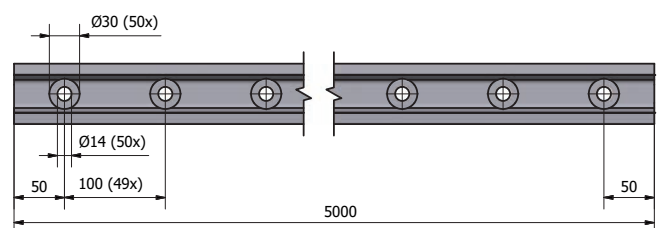
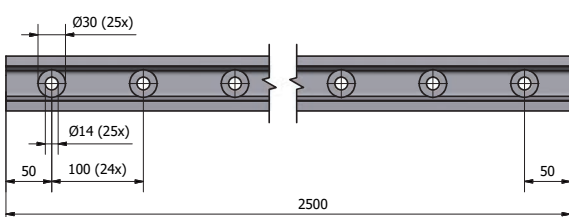
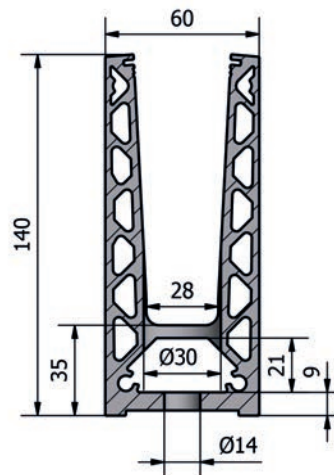

EasyMount 6020



Inside / Outside Corner 90°

Inside length 140 mm
Outside length 200 mm



Art.-No.	Finish
BO 6060203	Aluminium



End Cap left/right

suitable for left and right
Sold individually



Art.-No.	Finish
BO 6060204	Aluminium



Spacer

Sold in packs of 13



Art.-No.	Finish
BO 6060206	Aluminium



EasyMount 6021



EasyMount 6021, 0.74 - 1.5 kN Side Mount



The new EasyMount 6021 profile is the intelligent onward development of Bohle's popular EasyMount Side profile. By increasing the distance between pre-drilled holes, and by allowing the use of anchor bolts without a countersunk head, installation of the new 6021 profile is both faster and much more cost effective.

For use in interior or exterior applications, it can withstand line loads of up to 1.5kN. Glass mounting kits are available from 12mm up to 21.52mm.

Slimline, elegant and low maintenance

- Drainage holes built into profile
- Less fixings required to achieve 0.74kN (mounting distances approx. 400mm centres)
- For glass thickness between 12mm - 21.52mm

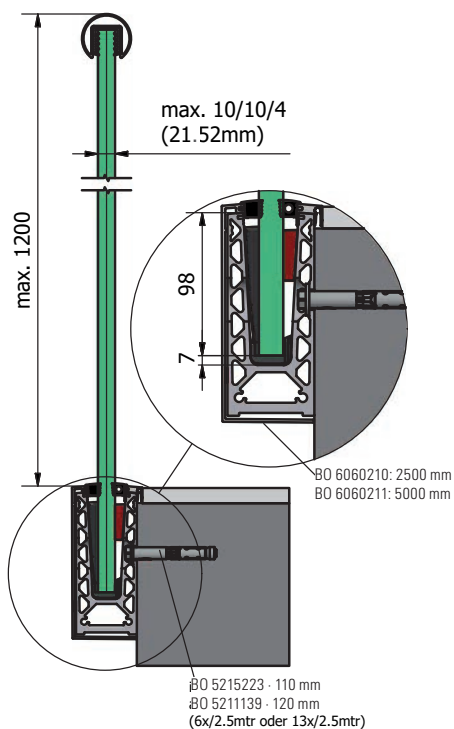

Art.-No.	Length · Material
BO 6060212	2500 mm · Aluminium
BO 6060215	5000 mm · Aluminium

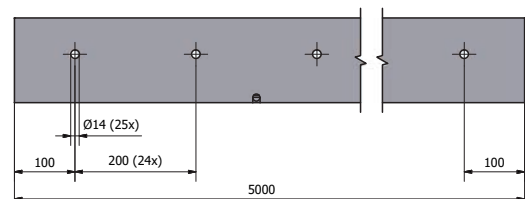
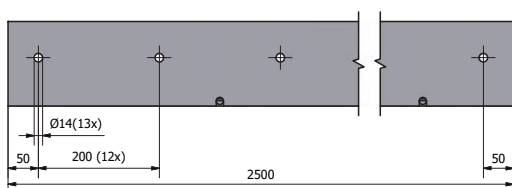
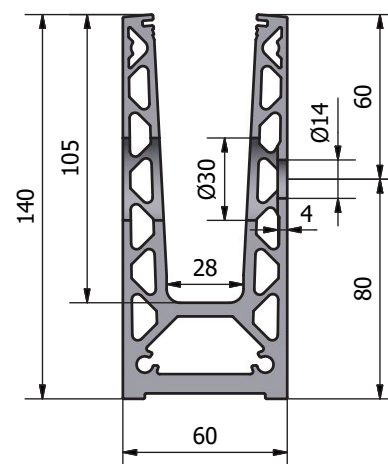

EasyMount TL-6021

Inside Corner 90°



Inside length 140 mm
Outside length 200 mm

Art.-No.	Finish
BO 6060213	Aluminium

Outside Corner 90°



Inside length 140 mm
Outside length 200 mm

Art.-No.	Finish
BO 6060214	Aluminium

End Cap Left



suitable for left
Sold individually

Art.-No.	Finish
BO 6060216	Aluminium

End Cap Left for use with Snapframe



suitable for left
Sold individually

Art.-No.	Finish
BO 6060217	Aluminium

End Cap Right



suitable for right
Sold individually

Art.-No.	Finish
BO 6060218	Aluminium

End Cap Right for use with Snapframe



suitable for right
Sold individually

Art.-No.	Finish
BO 6060219	Aluminium

Snapframe



With mounting strip
For use with End Caps BO 6060217 and BO 6060219

Art.-No.	Finish · Length
BO 6060210	Aluminium · 2500 mm
BO 6060211	Aluminium · 5000 mm

Profile for EasyMount Top mount

Bohle Profile for EasyMount Top top mount

i Rail load 1.0 kN · Material aluminium · Finish anodised E6/EV1



Please note:

You will find suitable installation kits under Bohle EasyMount Glass Mounting Kits.

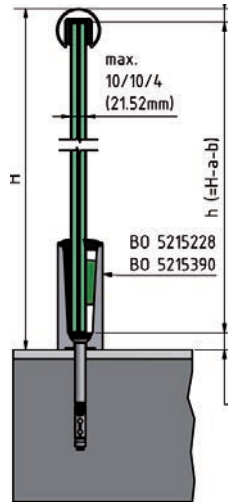
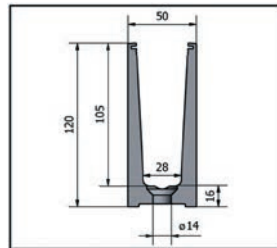
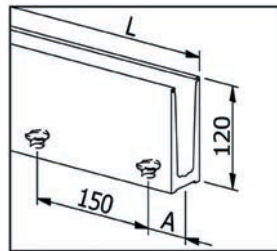

BO 5215228
BO 5215390

BO 5215340 - BO 5215360 EasyMount Vario = 22mm

Art.-No.	Description
BO 5215228	2500 mm · (A) 50 mm
BO 5215390	5000 mm · (A) 25 mm

Bohle Corner Inside / Outside

i For profile BO 5215228 + BO 5215390 · Material aluminium · Finish anodised E6/EV1

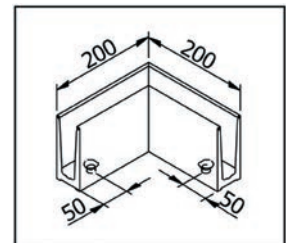

Art.-No.	Description
BO 5215229	

Profile for EasyMount Top mount

Bohle End Cap



Version left / right - For profile BO 5215228 / 5215390

Art.-No.

BO 5215230

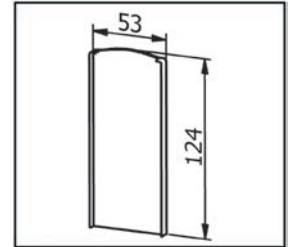

EasyMount Vario

Vario Glass Mounting Kits

The EasyMount Vario Glass Mounting Kits enable quick and easy installation. With a simple sliding movement the system can be adjusted by up to 40 mm. The Bohle mounting tool BO 5215281 enables you to work from the accessible side, making installation less time consuming.

Bohle Glass Mounting Kit EasyMount Vario rail load 1.0 kN



EasyMount Vario - for linear alignment

i For profile 2500 mm

Included in delivery:
2 x 2500 mm Rubber Profile
8 x Glass clamps

Art. No.	Glass thickness
BO 5215340	12 mm
BO 5215341	6/2/6 (12.76) mm
BO 5215342	6/4/6 (13.52) mm
BO 5215343	15 mm
BO 5215344	8/2/8 (16.76) mm
BO 5215345	8/4/8 (17.52) mm
BO 5215346	19 mm
BO 5215347	10/2/10 (20.76) mm
BO 5215348	10/4/10 (21.52) mm

EasyMount Vario - for linear alignment

i For profile 5000 mm

Included in delivery:
2 x 5000 mm Rubber Profile
16 x Glass clamps

Art. No.	Glass thickness
BO 5215352	12 mm
BO 5215353	6/2/6 (12.76) mm
BO 5215354	6/4/6 (13.52) mm
BO 5215355	15 mm
BO 5215356	8/2/8 (16.76) mm
BO 5215357	8/4/8 (17.52) mm
BO 5215358	19 mm
BO 5215359	10/2/10 (20.76) mm
BO 5215360	10/4/10 (21.52) mm

Bohle Mounting Tool



Mounting tool for Bohle EasyMount Vario balustrade system

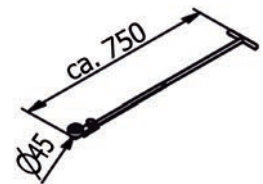

Art.-No.
BO 5215281

Bohle Mounting Tool for EasyMount Vario



Mounting tool for Bohle Vario balustrade system

Art.-No.
BO 5215284

Posiglaze

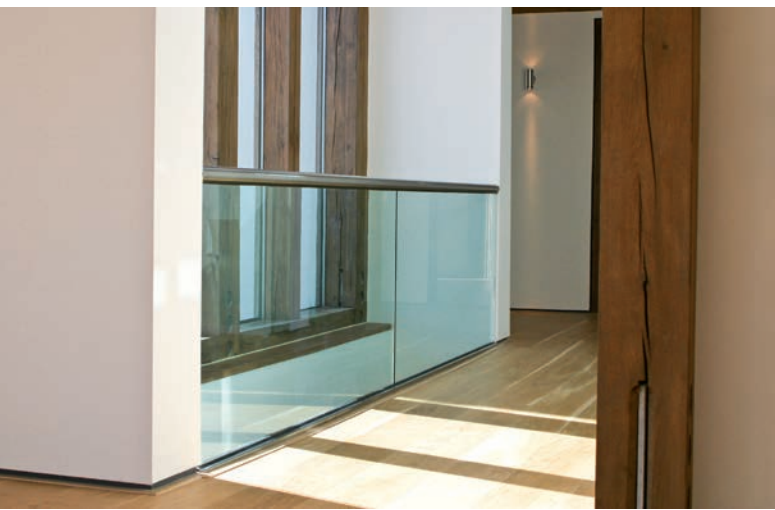

Posiglaze is an innovative aluminium channel system that holds glass panels in place for use on balustrades and partitions.

Posiglaze is

- Quick and easy to install
- Fully adjustable
- Lightweight and extremely strong
- Suitable for domestic and commercial applications
- Fully anodised in a stainless steel effect



Bohle Posiglaze Kit - Surface Mounting

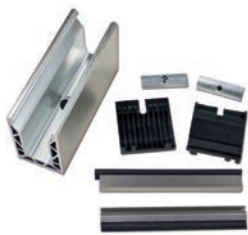

For surface mounting

i for glass thickness 12 mm, 15 mm, 17.5 mm, 19 mm and 21.5 mm

Art.-No.	Description
BO 6003401A	3000 mm BASE Kit for 12 mm glass
BO 6003401B	3000 mm BASE Kit for 15 mm glass
BO 6003401C	3000 mm BASE Kit for 17.5 mm glass
BO 6003401D	3000 mm BASE Kit for 19 mm glass
BO 6003401E	3000 mm BASE Kit for 21.5 mm glass

Bohle Posiglaze Kit - Face Fix Mounting



For face fix mounting

i for glass thickness 12 mm, 15 mm, 17.5 mm, 19 mm and 21.5 mm

Art.-No.	Description
BO 6003405A	3000 mm FACE Kit for 12 mm glass
BO 6003405B	3000 mm FACE Kit for 15 mm glass
BO 6003405C	3000 mm FACE Kit for 17.5 mm glass
BO 6003405D	3000 mm FACE Kit for 19 mm glass
BO 6003405E	3000 mm FACE Kit for 21.5 mm glass
BO 6003406	Side Cladding - 3000 mm length
BO 6003407	Cladding End Cap for use with Face Fix kits - left hand
BO 6003408	Cladding End Cap for use with Face Fix kits - right hand

Bohle End Cap for Surface Mounting



End caps for use with Posiglaze base kits.

Art.-No.	Description
BO 6003404	End cap for use without cladding
BO 6003430	Slot in end cap 316 stainless steel

Bohle Posiglaze Corner

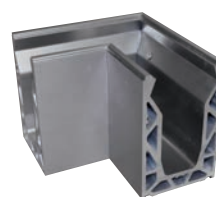

i 136 x 136 mm external.
100 x 100 mm internal

Art.-No.	Description
BO 6003413	Posiglaze corner

Bohle Additional Fitting Packs



Additional fitting packs for use with Base and Face fix Posiglaze channels

📌 for glass thickness 12 mm, 15 mm, 17.5 mm, 19 mm and 21.5 mm

Art.-No.	Description
BO 6003412A	Pack for 12 mm glass · for 3000 mm length
BO 6003415B	Pack for 15 mm glass · for 3000 mm length
BO 6003417C	Pack for 17.5 mm glass · for 3000 mm length
BO 6003419D	Pack for 19 mm glass · for 3000 mm length
BO 6003421E	Pack for 21.5 mm glass · for 3000 mm length
BO 6003425	Joining dowels, set of 2
BO 6003426	Adjustment Spanner
BO 6PGS012	1 m Spares Kit for 12 mm glass
BO 6PGS015	1 m Spares Kit for 15 mm glass
BO 6PGS017	1 m Spares Kit for 17.5 mm glass
BO 6PGS019	1 m Spares Kit for 19 mm glass
BO 6PGS021	1 m Spares Kit for 21.5 mm glass

Bohle Handrail



For use with the Posiglaze balustrade systems

📌 For glass thickness 12 mm, 15 mm, 17.5 mm, 19 mm and 21.5 mm.

Art.-No.	Description
BO 6003442	42.4 mm Ø · grade 316 · satin polished · 3000 mm long
BO 6003454	42.4 mm Ø · grade 316 · satin polished · 6000 mm

Bohle Handrail Gasket



Art.-No.	Description
BO 6003445A	Gasket · for 12 mm glass · 6 mtrs
BO 6003445B	Gasket · for 15 mm glass · 6 mtrs
BO 6003445C	Gasket · for 17.5 mm glass · 6 mtrs
BO 6003445D	Gasket · for 19 mm glass · 6 mtrs
BO 6003445E	Gasket · for 21.5 mm glass · 6 mtrs

Bohle Handrail Wall Connector



Art.-No.	Description
BO 6003444	Wall connector · for 42.4 mm handrail

Bohle Straight Connector



Art.-No.	Description
BO 6003445	Straight connector · for 42.4 mm handrail

Bohle Handrail End Cap



Art.-No.	Description
BO 6003443	Endcaps · for 42.4 mm handrail

Bohle Handrail 90° Connector



Art.-No.	Description
BO 6003446	90° connector · for 42.4 mm handrail

Bohle Handrail Articulated Connector



Art.-No.	Description
BO 6003447	Articulated connector · top · for 42.4 mm handrail
BO 6003447B	Articulated connector · bottom · for 42.4 mm handrail

Clamps

Clamps finishes



... 555 brushed stainless steel V4A
... 955 brushed stainless steel V2A

... 122 shiny chrome

... 516 polished stainless steel V4A

... 163 stainless steel look

... 100 zinc, mill finish

In this section you will find clamps for tempered glass and laminated safety glass up to a total thickness of 21.52 mm. The clamps are manufactured either of diecast zinc or stainless steel and are supplied with cover caps which match the finishes of the clamps.

To see the full range of Clamps visit our website www.bohle-group.com, or phone 0800 616151 for a full Fittings for Glass catalogue.

Clamps square 45 x 45 mm



finish code:

- ... 100
- ... 122
- ... 163
- ... 516
- ... 555
- ... 955

incl. securing pin



Art. No BO 8720 + finish code



42

Art. No BO 8722 + finish code



48

Art. No BO 8724 + finish code

Art. No.	Inserts for clamp · Glass thickness
BO 8820060	set with 8 pieces · tempered glass 6 mm
BO 8820080	set with 8 pieces · tempered glass 8 mm
BO 8820100	set with 8 pieces · tempered glass 10 mm
BO 8820090	set with 8 pieces · laminated safety glass 8.76 mm
BO 8820110	set with 8 pieces · laminated safety glass 10.76 mm
Art. No.	Description
BO 8920001	Securing Plate, Set of 4

Clamps square 55 x 55 mm



finish code:

- ... 516
- ... 555
- ... 955

incl. securing pin



Art. No BO 8740 + finish code



48

Art. No BO 8742 + finish code

Art. No.	Inserts for clamp · Glass thickness
BO 8840080	set with 8 pieces · tempered glass 8 mm
BO 8840100	set with 8 pieces · tempered glass 10 mm
BO 8840120	set with 8 pieces · tempered glass 12 mm
BO 8840090	set with 8 pieces · laminated safety glass 8.76 mm
BO 8840110	set with 8 pieces · laminated safety glass 10.76 mm
BO 8840130	set with 8 pieces · laminated safety glass 12.76 mm
BO 8840140	set with 8 pieces · laminated safety glass 13.52 mm
Art. No.	Description
BO 8940001	Securing Plate, Set of 4



"General Building Inspection Test Certificate"

For products displaying the logo "AbP", a "General Building Inspection Test Certificate" has been granted.

Bohle Clamps D-shaped 50 x 40 mm



finish code:
 ... 100
 ... 122
 ... 163
 ... 516
 ... 555
 ... 955

incl. securing pin



Art. No BO 8710 + finish code



Art. No BO 8712 + finish code

Art. No.	Inserts for clamp · Glass thickness
BO 8810060	set with 8 pieces · tempered glass 6 mm
BO 8810080	set with 8 pieces · tempered glass 8 mm
BO 8810100	set with 8 pieces · tempered glass 10 mm
BO 8810090	set with 8 pieces · laminated safety glass 8.76 mm
BO 8810110	set with 8 pieces · laminated safety glass 10.76 mm

Bohle Clamps square 70 x 55 mm



finish code:
 ... 516
 ... 555

incl. securing pin



Art. No BO 8750 + finish code



Art. No BO 8752 + finish code

Art. No.	Inserts for clamp · Glass thickness
BO 8850080	set with 8 pieces · tempered glass 8 mm
BO 8850100	set with 8 pieces · tempered glass 10 mm
BO 8850120	set with 8 pieces · tempered glass 12 mm
BO 8850090	set with 8 pieces · laminated safety glass 8.76 mm
BO 8850110	set with 8 pieces · laminated safety glass 10.76 mm
BO 8850130	set with 8 pieces · laminated safety glass 12.76 mm
BO 8850140	set with 8 pieces · laminated safety glass 13.52 mm
Art. No.	Description
BO 8950001	Securing Plate, Set of 4

Bohle Clamps D-shaped 63 x 45 mm



finish code:
 ... 100
 ... 122
 ... 163
 ... 516
 ... 555
 ... 955

incl. securing pin



Art. No BO 8730 + finish code



Art. No BO 8732 + finish code



Art. No BO 8734 + finish code

Art. No.	Description · Glass thickness
BO 8830060	set with 8 pieces · tempered glass 6 mm
BO 8830080	set with 8 pieces · tempered glass 8 mm
BO 8830100	set with 8 pieces · tempered glass 10 mm
BO 8830120	set with 8 pieces · tempered glass 12 mm
BO 8830090	set with 8 pieces · laminated safety glass 8.76 mm
BO 8830110	set with 8 pieces · laminated safety glass 10.76 mm
BO 8830130	set with 8 pieces · laminated safety glass 12.76 mm

Bohle Clamps square 70 x 55 mm heavy duty



finish code:
 ... 516
 ... 555

incl. securing plate



Art. No BO 8755 + finish code



Art. No BO 8757 + finish code

Art. No.	Inserts for clamp · Glass thickness
BO 8855170	set with 8 pieces · laminated safety glass 16.76 mm
BO 8855180	set with 8 pieces · laminated safety glass 17.52 mm
BO 8855210	set with 8 pieces · laminated safety glass 20.76 mm
BO 8855220	set with 8 pieces · laminated safety glass 21.52 mm
Art. No.	Description
BO 8955001	Securing Plate, Set of 4

New Post & Rail System



End Post with Saddle



Posts supplied complete with saddle and 2 clamps . Post 48.3 mm x 2 mm . 316 grade stainless steel . D clamps 63 x 45 mm to suit 10 mm glass . Designed so that the overall balustrade height is 1100 mm once handrail has been added.

Art.-No.	Description
BO 6ENDPOST	End post complete with 2 clamps



Middle Post with Adjustable Saddle



Posts supplied complete with saddle and 4 clamps . Post 48.3 mm x 2 mm . 316 grade stainless steel . D clamps 63 x 45 mm to suit 10 mm glass . Designed so that the overall balustrade height is 1100 mm once handrail has been added.

Art.-No.	Description
BO 6MAJPOST	Middle post with adjustable saddle



Middle Post with Straight Saddle



Posts supplied complete with saddle and 4 clamps . Post 48.3 mm x 2 mm . 316 grade stainless steel . D clamps 63 x 45 mm to suit 10 mm glass . Designed so that the overall balustrade height is 1100 mm once handrail has been added.

Art.-No.	Description
BO 6MIDPOST	Middle post with straight saddle



Corner Post with Saddle



Posts supplied complete with saddle and 4 clamps . Post 48.3 mm x 2 mm . 316 grade stainless steel . D clamps 63 x 45 mm to suit 10 mm glass . Designed so that the overall balustrade height is 1100 mm once handrail has been added.

Art.-No.	Description
BO 690DPOST	90° corner post with saddle



Handrail

Tube, 48.3 mm x 2 mm x 5000 mm,
316 stainless steel satin



Art.-No.	Description
BO 6003460	Handrail tube



Handrail 90° Connector

90° rounded, 48.3 mm x 2 mm,
316 stainless steel satin



Art.-No.	Description
BO 6003461	Flush elbow



Handrail Articulated Connector

(0°-70°) 48.3 mm x 2 mm,
316 stainless steel satin



Art.-No.	Description
BO 6003462	Adjustable flush angle



Handrail Straight Connector

48.3 mm x 2 mm,
316 stainless steel satin



Art.-No.	Description
BO 6003463	Tube connector



Handrail Wall Connector

48.3 mm x 2 mm,
316 stainless steel satin



Art.-No.	Description
BO 6003464	Wall connector



Handrail End Cap, arched

48.3 mm x 2 mm,
316 stainless steel satin



Art.-No.	Description
BO 6003465	Arched end cap

Single Point Fixings

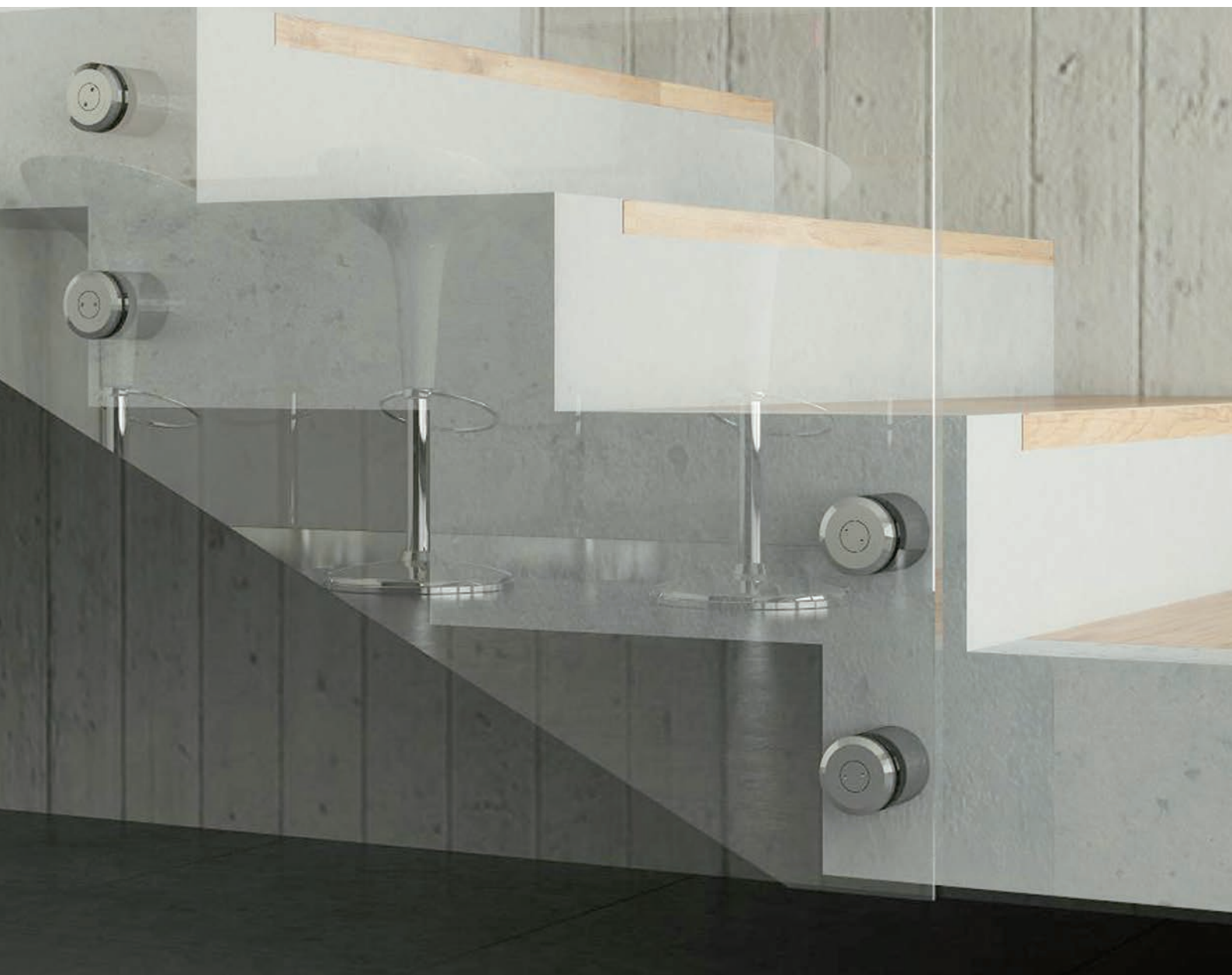

Point fixings for interior and exterior applications. With Bohle point fixings there are no limits to your creativity, whether they are for railing systems, interior work or entire wall cladding. Adjustable and easy to install, Bohle point fixings are an enhancement to any modern construction project.

To see the full range of Single Point Fixings visit our website www.bohle-group.com, or phone 0800 616151 for a full Fittings for Glass catalogue.



Bohle Single Point Fixings 50 mm



- Easy installation and fixing of the glass
- Sturdy design in accordance with DIN EN 1991-1-1
- High precision and quality finish
- Adjustment of distance is possible after glass mounting

For tempered and laminated safety glass · use at least 4 pieces depending on glass dimensions · Diagrams for glass processing can be found in our Online Shop · Can be adjusted through elongated hole in connection element.

① Size Ø 50 · Drill hole in glass 30 mm Ø · Adjustment range 0 - 5 mm

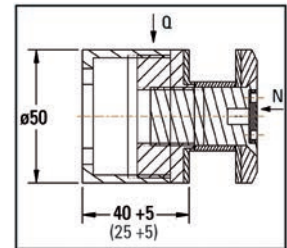

Art. No.	Mounting distance glass/wall (adjustable 0 - 5 mm) · Glass thickness · Glass thickness · Stainless steel · Max. load bearing capacity
BO 5214026	25 mm · tempered glass 10 - 12 mm · laminated safety glass 11.52 - 13.52 mm · AISI 304 · Q: 3.5; N: 6.0 kN
BO 5214027	40 mm · tempered glass 10 - 19 mm · laminated safety glass 11.52 - 21.52 mm · AISI 304 · Q: 3.5; N: 5.0 kN
BO 5214034	25 mm · tempered glass 15 - 19 mm · laminated safety glass 17.52 - 21.52 mm · AISI 304 · Q: 4.0; N: 6.0 kN
BO 5214028	25 mm · tempered glass 10 - 12 mm · laminated safety glass 11.52 - 13.52 mm · AISI 316 · Q: 4.0; N: 6.0 kN
BO 5214029	40 mm · tempered glass 10 - 19 mm · laminated safety glass 11.52 - 21.52 mm · AISI 316 · Q: 3.5; N: 5.0 kN
BO 5214035	25 mm · tempered glass 15 - 19 mm · laminated safety glass 17.52 - 21.52 mm · AISI 316 · Q: 4.0; N: 6.0 kN

Bohle Single Point Fixings 40 mm



- Easy installation and fixing of the glass
- Sturdy design in accordance with DIN EN 1991-1-1
- High precision and quality finish
- Adjustment of distance is possible after glass mounting

For tempered and laminated safety glass · use at least 4 pieces depending on glass dimensions · Diagrams for glass processing can be found in our Online Shop · Can be adjusted through elongated hole in connection element.

① Size Ø 40 · Drill hole in glass 25 mm Ø · Adjustment range 0 - 5 mm

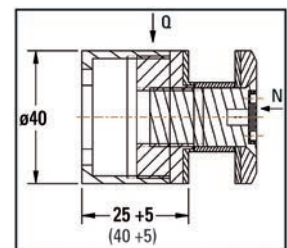

Art. No.	Mounting distance glass/wall (adjustable 0 - 5 mm) · Glass thickness · Glass thickness · Stainless steel · Max. load bearing capacity
BO 5214030	25 mm · tempered glass 10 - 12 mm · laminated safety glass 11.52 - 13.52 mm · AISI 304 · Q: 3.5; N: 5.5 kN
BO 5214031	40 mm · tempered glass 10 - 19 mm · laminated safety glass 11.52 - 21.52 mm · AISI 304 · Q: 3.0; N: 4.5 kN
BO 5214036	25 mm · tempered glass 15 - 19 mm · laminated safety glass 17.52 - 21.52 mm · AISI 304 · Q: 3.5; N: 5.5 kN
BO 5214032	25 mm · tempered glass 10 - 12 mm · laminated safety glass 11.52 - 13.52 mm · AISI 316 · Q: 3.5; N: 5.5 kN
BO 5214033	40 mm · tempered glass 10 - 19 mm · laminated safety glass 11.52 - 21.52 mm · AISI 316 · Q: 3.0; N: 4.5 kN
BO 5214037	25 mm · tempered glass 15 - 19 mm · laminated safety glass 17.52 - 21.52 mm · AISI 316 · Q: 3.5 N: 5.5 kN

Single Point Fixings

Bohle Single Point Fixings



ⓘ Diameter (D) 60 mm · Length (L) 130 mm ·
Glass thickness 13.5 - 21.5 mm

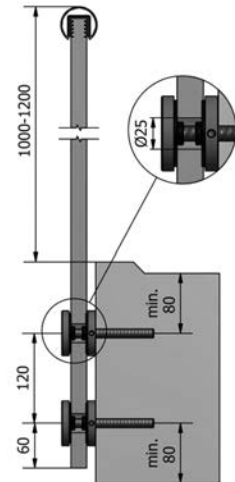
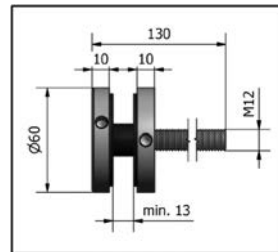
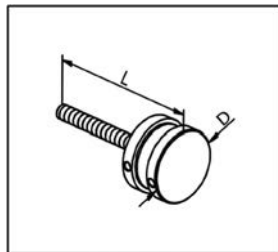

Art. No.	Finish
BO 5214060	stainless steel (V2A)
BO 5214062	stainless steel (V4A)

Bohle Single Point Fixings



ⓘ Diameter (D) 80 mm · Length (L) 195 mm ·
Glass thickness 15 - 31.5 mm

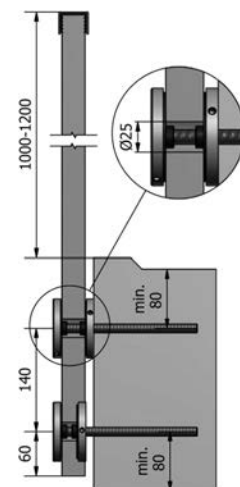
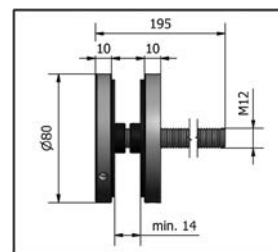
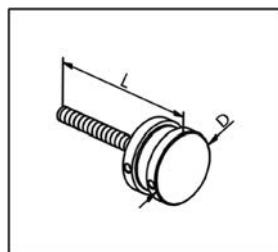

Art. No.	Finish
BO 5214061	stainless steel (V2A)
BO 5214063	stainless steel (V4A)

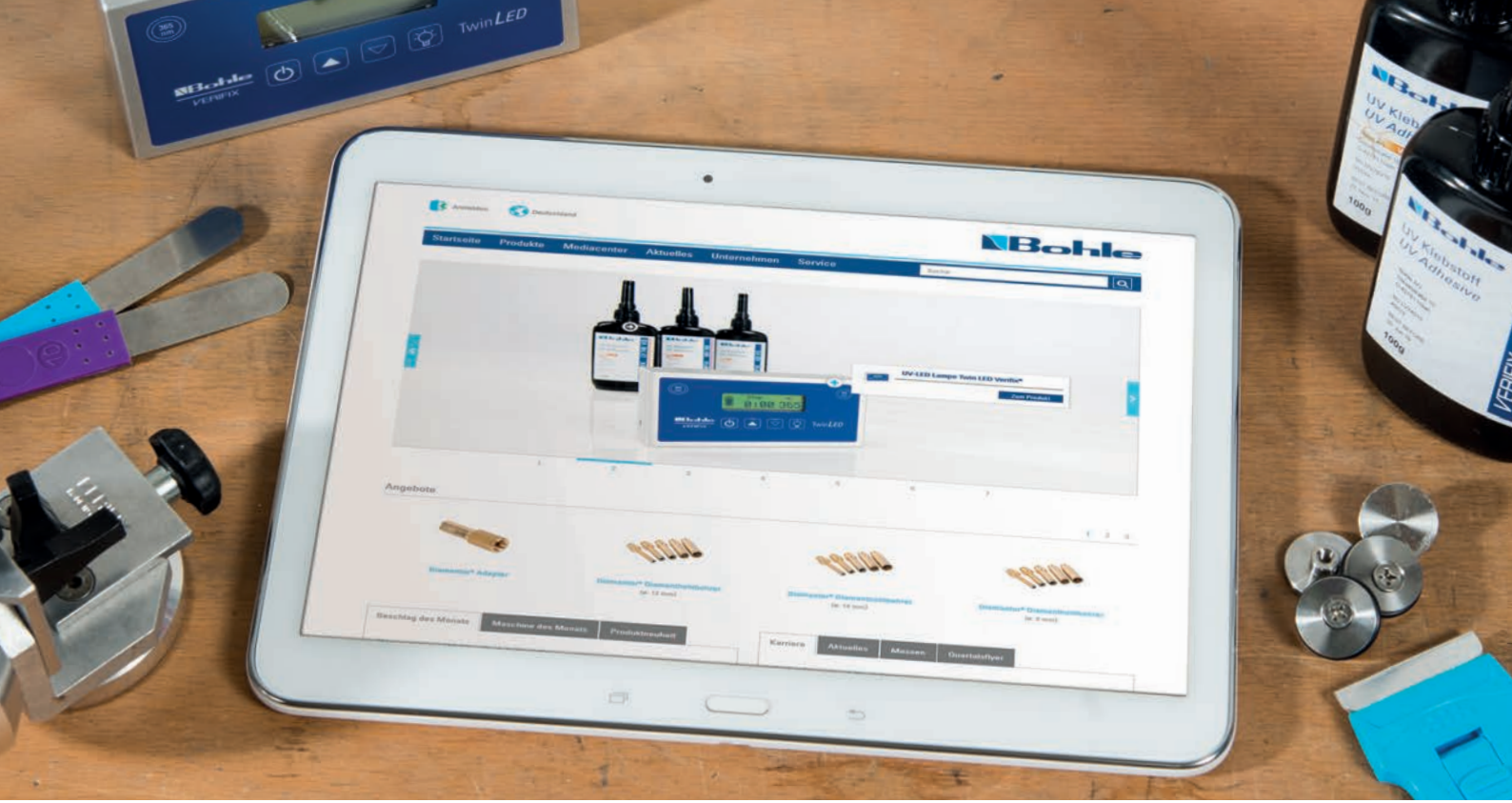

The Bohle Online Shop

The Bohle Online Shop offers you our latest product range around the clock in a clearly structured and informative way.

The Online Shop features clearer layout, better performance and improved functionality.

www.bohle-group.com



Optimised for all digital devices.

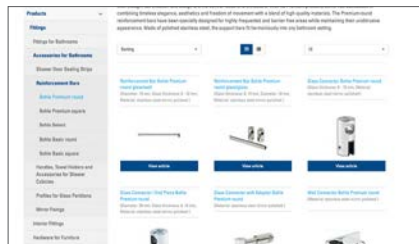

Clearly structured product presentation with filter function.



Convenient search function.

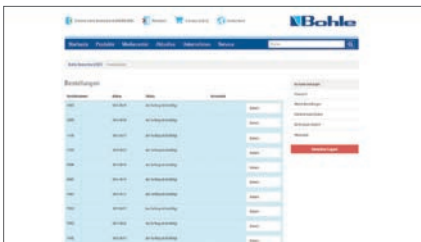

Secure customer area with online and offline order history.

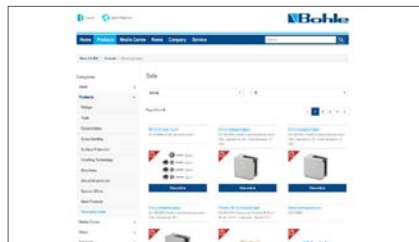

New offers and deals always updated.

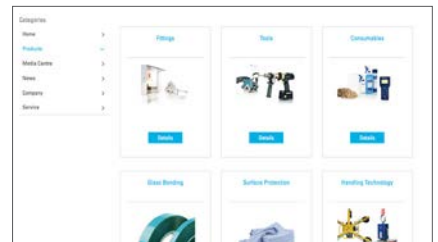

24/7 the latest product portfolio.

UK & ROI Sales Conditions

1. Definitions

- Conditions: the terms and conditions set out in this document as amended from time to time in accordance with condition 2.c.
- Contract: the contract between Bohle and the Purchaser for the sale and purchase of the Products in accordance with these Conditions.
- Order: the Purchaser's order for the Products, as set out in the Purchaser's order form and/or Bohle's written record of any telephone order.
- Products: the products for any part of them set out in the Order.
- Purchaser: the person or firm who purchases the Products from Bohle.
- Specification: any specification for the Products, including any related plans and drawings, that is agreed in writing by the Purchaser and Bohle.
- Bohle: the supplier of the Products, Bohle Limited, registered in England and Wales with company number 00644864

2. Application

- These conditions apply to the Contract, as well as all statements made by Bohle in catalogues, brochures, price lists, quotations, on the internet or verbally, to the exclusion of any terms the Purchaser may seek to impose or which may be implied by custom, trade, practice or course of dealing. Any samples, drawings, descriptive matter, or advertising produced by Bohle and any descriptions or illustrations contained in Bohle's catalogues or brochures are produced for the sole purpose of giving an approximate idea of the Products described in them. They shall not form part of the Contract or have any contractual force.
- The Contract constitutes the entire agreement between the parties. The Purchaser acknowledges that it has not relied on any statement, promise or representation made or given by or on behalf of Bohle which is not set out in the Contract.
- Variations of these conditions are only valid if confirmed by Bohle in writing.
- Placing an Order constitutes the Purchaser's acceptance of these Conditions. The Purchaser will be responsible for ensuring that the terms of the Order and any Specification submitted by the Purchaser are complete and accurate.
- Bohle may change these Conditions at its discretion (and Bohle will notify the Purchaser of any amendments to the Conditions). For the avoidance of doubt, the Purchaser will be bound by the Conditions in force at the date of placing the relevant Order.

3. Orders/Contract

- Any Orders received (whether by mail, internet, phone or fax) will be deemed to have been accepted unless the Purchaser is otherwise notified by Bohle.

4. Price & Payment Terms

- Quotations are only valid in writing and for the stated period. A quotation shall not constitute an offer.
- The price for the Products shall be the price set out in Bohle's published price list at the date of the Purchaser's order, unless otherwise agreed in writing with Bohle.
- Bohle reserves the right to amend the specification of the Products at any time but guarantees that the amended products will deliver at least equivalent functionality and performance.
- Prices are to be understood in £(GBP) unless otherwise agreed with Bohle, net of any deductions or discounts applicable, exclusive of VAT (which shall be payable by the Purchaser in addition on receipt of a VAT invoice from Bohle), Ex-works (as defined by Incoterms 2010), excluding all other taxes, transport costs, insurance and installation. Packing, postage and freight are included in the price for orders above £150 (£200 net of VAT).
- Payments in £(GBP) shall be made to National Westminster Bank, sort code 01-05-63, account number 19264830. Payments in €(EUR) shall be made to Ulster Bank, sort code 985330, account number 08117189. Swift code and IBAN information can be found on invoices.
- Please note that deliveries of small or unwieldy orders (such as L-squares, straight edges, mirror profiles, long-lengths etc.) may result in a relatively high transport cost. Purchasers may consolidate such products with other orders and agree a transport cost with Bohle prior to delivery.
- Carriage to off-shore UK Islands will be charged extra at cost.
- Bohle reserves the right to adjust prices due to reasons beyond its control including exchange rates, production cost, duties, insurance, freight and other purchase costs (incl. for components & services). Bohle may also adjust prices if the Purchaser requests a change in delivery date, quantity or type of Products ordered, or the Specification, or if the Purchaser causes a delay due to any information or instructions given or not given by it.
- Bohle may invoice the Purchaser for the Products on or at any time after the Order is placed.
- Payment is to be made:
 - in advance by wire transfer or by irrevocable, confirmed letter of credit issued to Bohle's indicated bank or by cheque; or
 - if so agreed with Bohle in writing prior to the Purchaser placing an Order, within 30 days of the date of Bohle's invoice, subject to an agreed credit limit; or
 - if so agreed with Bohle in writing prior to the Purchaser placing an Order, by another payment method including credit or charge card. Cheques may only be accepted conditionally.
- With the exception of clause 4.i, processing of any Order will not commence until clearance of funds.
- All bank charges are for the account of the Purchaser unless otherwise agreed in writing prior to Order.
- Without prejudice to any other right it may have, Bohle may suspend deliveries or service until payment is received in full.
- Any dispute in relation to a particular Order shall not entitle the Purchaser to withhold payment in relation to any other Order.
- Bohle shall be entitled to charge interest on late payments at a rate of 6% above the minimum bank rate of the European Central Bank on the amount overdue. Such interest shall accrue on a daily basis from the due date until the date of actual payment of the overdue amount, whether before or after judgment. Any costs incurred by Bohle in connection with receiving a late payment or recovering any overdue sum shall be paid by the Purchaser.

5. Delivery/Title/Risk

- Products are dispatched from such of Bohle's warehouses as is the most appropriate location for Bohle. The delivery period stated in any Order confirmation is approximate and time of delivery is not of the essence. Delays in delivery do not justify any kind of compensation except as otherwise expressly set out in these Conditions.
- Bohle will deliver the Products to the location set out in the Order or such other location as the parties may agree (Delivery Location) at any time after Bohle notifies the Purchaser that the Products are ready.
- Delivery of the Products shall be completed when the Products arrive at the Delivery Location.
- If the Products are not available or have been modified, Bohle reserves the right to supply similar products of equivalent functionality.
- Deliveries may be made in instalments and each such instalment shall constitute a separate Contract which may be invoiced separately. Any right to cancel one instalment shall not entitle the Purchaser to cancel any other instalment.
- Bohle shall be entitled to make partial delivery of any Order if, for example, certain Products are unavailable. Partial delivery shall not entitle the Purchaser to reject the Order.
- The Purchaser shall not be entitled to reject the Products if Bohle delivers up to and including 5% more or less than the quantity of Products ordered, but a pro

rata adjustment shall be made to the Order invoice on receipt of notice from the Purchaser that the wrong quantity of Products was delivered.

- If the Purchaser refuses to accept a delivery without Bohle's agreement, he must pay Bohle's expenses or loss resulting from that refusal, including storage costs, until he accepts delivery. If the Purchaser has not accepted delivery of the Products within 10 working days of the date that Bohle originally delivered the Products to the Delivery Location, Bohle may resell or otherwise dispose of part or all of the Products and charge the Purchaser for any reasonable costs in connection with the storage and sale of the Products. If the Purchaser has paid in advance for the Products, Bohle will refund the purchase price less any such costs as well as any shortfall below the price of the Products.
- Bohle shall not be liable for any delay in delivery or failure to deliver the Products that is caused by the Purchaser's failure to provide Bohle with adequate delivery instructions or by any other act or omission of the Purchaser.
- If Bohle fails to deliver the Products, its liability shall be limited to the costs and expenses incurred by the Purchaser in obtaining replacement goods similar in description and quality in the cheapest market available, less the price of the Products.
- Risk in the Products shall pass to the Purchaser on completion of delivery.
- Title to the Products passes on receipt by Bohle of full payment. Until then, the Purchaser must:
 - hold the goods on a fiduciary basis as Bohle's bailee;
 - insure and store the Products separately and keep them in satisfactory condition;
 - not modify, pledge, sell or part with possession of the Products; and
 - notify Bohle if any of the events in clause 9.b shall occur.On request the Products shall be made available to Bohle for re-collection and the Purchaser shall provide any information relating to the Products as Bohle shall request. Until title in the Products has passed to the Purchaser, the Purchaser shall not purport to be the owner of the Products and shall not show such Products as stock in its accounts.
- Bohle may at any time upon reasonable notice enter the Purchaser's premises (or any other premises where the Products are stored) for the purpose of inspecting the Products and ensuring the Purchaser's compliance with this Contract. The Purchaser shall ensure that Bohle is granted access to such premises and facilities as are reasonably necessary for the purpose of this clause.
- If before title to the Products passes to the Purchaser, the Purchaser becomes subject to any of the events listed in clause 9.b, or Bohle reasonably believes that any such event is about to happen and notifies the Purchaser accordingly, then, without limiting any other right or remedy Bohle may have, Bohle may at any time require the Purchaser to deliver up the Products and, if the Purchaser fails to do so may, together with appropriate transport and personnel, promptly enter any premises of the Purchaser or of any third party where the Products are stored in order to recover them.

6. Acceptance

- Delivered Products must be inspected by the Purchaser promptly upon receipt of the Products. If the Purchaser does not claim any discrepancies in the delivery within 3 working days after receipt of the shipment, the Purchaser will be deemed to have accepted the Products in full.
- If Bohle agrees that the Purchaser may return Products, they must be in their original condition (unused, undamaged, in original packaging) and accompanied by a return note as well as proof of purchase. Any return charges must be paid by the Purchaser and a re-stocking charge of 20% of the Products value or £20 (GBP) whichever is the greater will be charged to the Purchaser for any goods returned through no fault of Bohle.
- The Purchaser may not return any Products which have been custom made to the Purchaser's specification, or where any item comprised in the Order has been specially ordered by Bohle to satisfy such Order.
- Products received in an obviously damaged condition (including damaged packaging) should be either rejected by the Purchaser on delivery, or, if signed for, then signed for as "Received in damaged condition", regardless of carrier paperwork instructions and of carrier driver information. Failure to do this will result in any claim for damage being rejected.

7. Warranty

- Subject to clause 7.c, Bohle guarantees that the Products will be free from defects for 6 months after date of invoice (Warranty Period). Should the Purchaser notify Bohle in writing within the Warranty Period of a defective product, Bohle will repair or replace the Product (at its discretion) within a reasonable time, provided that Bohle shall have reasonable opportunity to examine the Product at either the Purchaser's or Bohle's premises (at Bohle's option).
- Any return of Products must be approved by Bohle in writing before being effected and the Purchaser shall bear the cost of carriage, postage and packaging. Any shipments received by Bohle where such costs have not been paid by the Purchaser will not be accepted.
- Bohle will not accept warranty protection claims for damage caused by:
 - the Purchaser's failure to comply with Bohle's instructions (or if none are given, good industry practice) regarding the installation, use, storage, commissioning, modification or repair by the Purchaser or any unauthorised third party of the Products;
 - the Purchaser making further use of the Products after giving notice in accordance with condition 7.a;
 - Bohle following any drawing, design or Specification supplied by the Purchaser;
 - the Purchaser altering or repairing the Products without the written consent of Bohle;
 - fair wear and tear, willful damage, negligence or abnormal storage or working conditions; or
 - the Purchaser's failure to comply with Bohle's instructions (or if none are given, good industry practice) regarding the installation, use, storage, and regulatory requirements.
- Except as provided in this clause 7, Bohle shall have no liability to the Purchaser in respect of the Products' failure to comply with the warranty set out in clause 7.a.
- Except as set out in these Conditions, all warranties, conditions and other terms implied by statute or common law are, to the fullest extent permitted by law, excluded from the Contract.
- These Conditions shall apply to any repaired or replacement Products supplied by Bohle.

8. Liability

- Nothing in these Conditions shall limit or exclude Bohle's liability for:
 - death or personal injury caused by its negligence, or the negligence of its employees, agents or subcontractors (as applicable);
 - fraud or fraudulent misrepresentation;
 - breach of the terms implied by section 12 of the Sale of Goods Act 1979; or
 - any matter in respect of which it would be unlawful for Bohle to exclude or restrict liability.
- Subject to clause 8.a:
 - Bohle shall under no circumstances whatever be liable to the Purchaser, whether in contract, tort (including negligence), breach of statutory duty, or otherwise, for any loss of profit, or any indirect or consequential loss arising under or in connection with the Contract; and
 - Bohle's total liability to the Purchaser in respect of all other losses arising under or in connection with the Contract, whether in contract, tort (including

negligence), breach of statutory duty, or otherwise, shall in no circumstances exceed (the lesser of) [repair or replacement of the Products] or [£x]m.

9. Termination

- If the Purchaser becomes subject to any of the events listed in condition 9.b, or Bohle reasonably believes that the Purchaser is about to become subject to any of them and notifies the Purchaser accordingly, then without limiting any other right or remedy Bohle may have, Bohle may cancel or suspend all further deliveries under the Contract or under any other contract between the Purchaser and Bohle without incurring any liability to the Purchaser, and all outstanding sums in respect of Products delivered to the Purchaser shall become immediately due.
- For the purpose of condition 9.a, the relevant events are:
 - the Purchaser becomes insolvent, or an order is made or a resolution is passed for the winding up of the Purchaser (other than voluntarily) for the purpose of solvent amalgamation or reconstruction), or if an administrator, administrative receiver or receiver is appointed in respect of the whole or any part of the Purchaser's assets or business, or if the Purchaser makes any composition with its creditors or takes or suffers any similar or analogous action in consequence of debt, or (if the Purchaser is an individual) is the subject of a bankruptcy petition or order, or any event which has an effect equivalent or similar occurs in any jurisdiction to which the Purchaser is subject;
 - the Purchaser suspends, threatens to suspend, ceases or threatens to cease to carry on all or substantially the whole of its business;
 - the Purchaser's financial position deteriorates to such an extent that in Bohle's opinion the Purchaser's capability to adequately fulfill its obligations under the Contract has been placed in jeopardy; and
 - (being in individual) the Purchaser dies or by reason of illness or incapacity (whether mental or physical) is incapable of managing his or her own affairs or becomes a patient under any mental health legislation.
- Bohle may terminate the Contract, including any Order placed but not yet processed, immediately upon written notice to the Purchaser if:
 - the Purchaser is in material breach of any of the terms of this Contract and fails to remedy such breach within [14] days of written notice requiring it to do so by Bohle; or
 - the Purchaser has failed to pay any sum due under this Contract by its due date and such sum remains unpaid within [14] days of written notice by Bohle requiring the Purchaser to pay such sum in full.
- All sums payable under this Contract shall, upon termination of the Contract or any relevant Order (as appropriate) become immediately due and payable.
- Upon termination of the Contract, the Purchaser shall deliver to Bohle any Products in its possession to which title has not passed to the Purchaser. Failure to do so within a reasonable time shall entitle Bohle (without prejudice to any other right or remedy available to Bohle) to enter onto the Purchaser's premises or such other premises where the Products are stored, together with appropriate transport and personnel, to repossess the Products.
- Termination of the Contract, however arising, shall not affect either of the parties' rights and remedies that have accrued at termination. Clauses which expressly or by implication survive termination of the Contract shall continue in full force and effect.

10. Force Majeure

- Bohle shall not be liable for failure or delays in delivery or service caused by circumstances beyond their reasonable control (which may include strikes, lock-outs or other industrial disputes whether involving its own workforce or a third party's), failure of energy sources or transport network, acts of God, war, terrorism, riot, civil commotion, interference by civil or military authorities, national or international calamity, armed conflict, malicious damage, breakdown of plant or machinery, nuclear, chemical or biological contamination, sonic boom, explosions, collapse of building structures, fires, floods, storms, earthquakes, loss at sea, epidemics or similar events, natural disasters or extreme adverse weather conditions, or default of suppliers or subcontractors) and Bohle will be entitled to an appropriate delivery time extension for the fulfillment of the Order.

11. Jurisdiction

- The Contract, and any dispute or claim arising out of or in connection with it or its subject matter or formation (including non-contractual disputes or claims), shall be governed by, and construed in accordance with, English law, and the parties irrevocably submit to the exclusive jurisdiction of the courts of England and Wales.

12. General

- Bohle may at any time assign, transfer, charge, subcontract or deal in any other manner with all or any of its rights or obligations under the Contract. The Purchaser may not assign, transfer, charge, subcontract or deal in any other manner with all or any of its rights or obligations under the Contract without the prior written consent of Bohle.
- Any notice or other communication given to a party under or in connection with the Contract shall be in writing, addressed to that party at its registered office (if it is a company) or its principal place of business (in any other case) or such other address as that party may have specified to the other party in writing in accordance with this clause, and shall be delivered personally, sent by pre-paid first class post, recorded delivery, commercial courier, fax or e-mail.
- A notice or other communication shall be deemed to have been received: if delivered personally, when left at the address referred to in clause 12.b; if sent by pre-paid first class post or recorded delivery, at 9.00 am on the second working day after posting; if delivered by commercial courier, on the date and at the time that the courier's delivery receipt is signed; or, if sent by fax or e-mail, one working day after transmission.
- The provisions of clauses 12.b and 12.c shall not apply to the service of any proceedings or other documents in any legal action.
- If any court or competent authority finds that no provision of the Contract (or part of any provision) is invalid, illegal or unenforceable, that provision or part-provision shall, to the extent required, be deemed to be deleted, and the validity and enforceability of the other provisions of the Contract shall not be affected. If any invalid, unenforceable or illegal provision of the Contract would be valid, enforceable and legal if some part of it were deleted, the provision shall apply with the minimum modification necessary to make it legal, valid and enforceable.
- A waiver of any right or remedy under the Contract is only effective if given in writing and shall not be deemed a waiver of any subsequent breach or default. No failure or delay by a party to exercise any right or remedy provided under the Contract shall constitute a waiver of that or any other right or remedy, nor shall it preclude or restrict the further exercise of that or any other right or remedy. No single or partial exercise of such right or remedy shall preclude or restrict the further exercise of that or any other right or remedy.
- A person who is not a party to the Contract shall not have any rights under or in connection with it.

last update: 03/10/2013

How to contact Bohle

Bohle Ltd.

Bohle Online Shop www.bohle-group.com

Sales Telephone 0800 616151
Sales Fax 0161 344 0111
Machinery Sales & Support 0161 342 1104
Account Payments Direct 0161 342 1112
E-Mail info@bohle.ltd.uk
Pickup and Postal Address Fifth Avenue,
Tameside Park, Dukinfield
Cheshire SK16 4PP

Office opening times

Monday to Friday 8.00 am - 5.00 pm

Collection point opening times

Monday to Friday 9.00 am - 3.30 pm

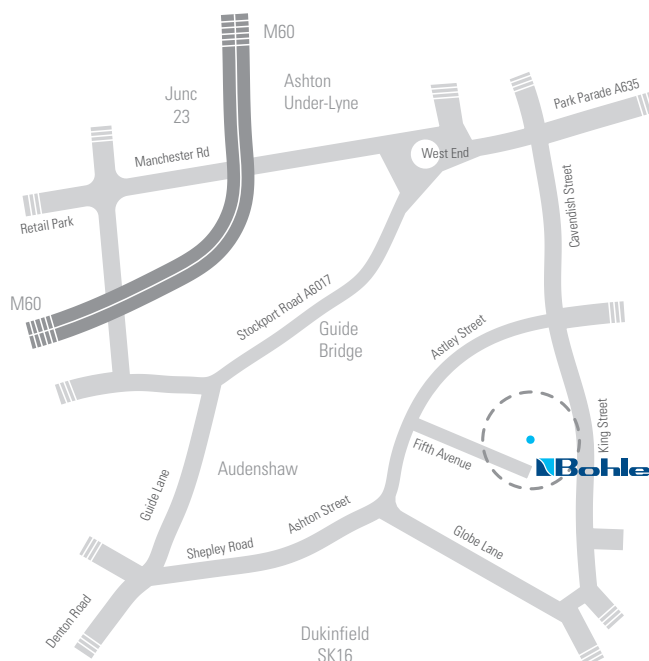

Notes about this catalogue

With the printing of this catalogue, all previous catalogues or parts thereof, are no longer valid. Our offers apply to retail, trade and industry. Technical specifications (dimensions, weights, materials, etc.) and other specifications (design, colour, etc.) are subject to change. The range of products can change during the time this catalogue is current. In particular, we reserve the right to remove individual articles without prior notice. Please request further details from your Bohle contact person. Print-related colour variations are possible. Bohle AG is not liable for any printing or other errors and omissions in this catalogue. For many of the articles protective rights such as patents, trademarks, design copyrights, etc. have been registered or are pending registration - also by third parties. Terms and Conditions apply.

© Copyright by Bohle - This catalogue is protected in all parts (texts, photos, images etc.) by copyright. Any use outside the strict limits of copyright laws without written permission of Bohle AG is not permitted. This applies in particular to duplications, reprints, translations, microfilming as well as saving and processing in electronic systems.

United Kingdom and Ireland

Bohle Ltd.
Fifth Avenue
Tameside Park · Dukinfield
Cheshire · SK16 4PP

T +44 161 3421100
F +44 161 3440111
info@bohle.ltd.uk

www.bohle-group.com