

Kensington Traders Limited

Stainless Steel and Glass Balustrade Brochure

Edition 21

T: 01582 563 794

F: 01582 491 925

E: Sales@kensingtonforge.co.uk

W: www.balustrade-systems.com



BRITISH STAINLESS
STEEL ASSOCIATION



42.4 x 2.5mm Components: 1-7

48.3 x 2.5mm Components: 8-14

50.8 x 1.5mm Components: 15-16

50.8 x 3mm Components: 17-24

60.3 x 4mm Components: 25-26

Adjustable Channel (Top + Side Fixing): 27-38

Rubber Gaskets and Capping Rails: 39-40

Tubes: 41

Slotted Tube Components: 42-43

New Glass Fittings: 44-61

Glass Canopy Fittings: 62-63

Stainless Steel Weldable Clamps: 64-65

Shower Fittings: 66-69

Handrail Support Brackets: 70-72

Stainless Steel Plates: 73-74

Stainless Steel Wire Fittings: 75-76

Anti-Skateboard Fittings: 77-78

LED System, Accessories, & Brochures

*Test reports are available upon request

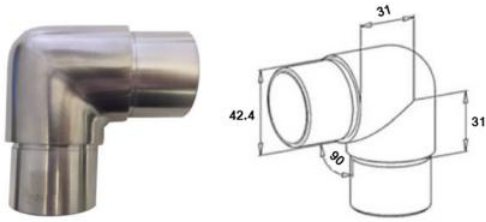

RV1003
90 Degree Radius Bend
304/316

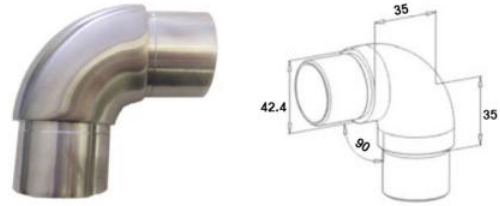

RV1008
90 Degree Radius Bend
304/316

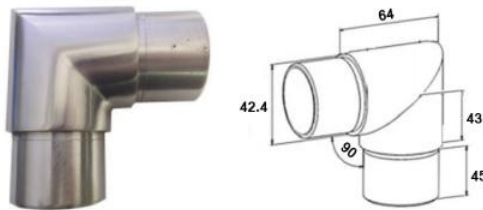

RV1005
90 Degree Sharp Bend
304/316

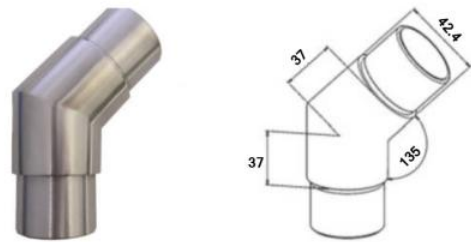

RV1007
135/45 Degree Tube Connector
304/316

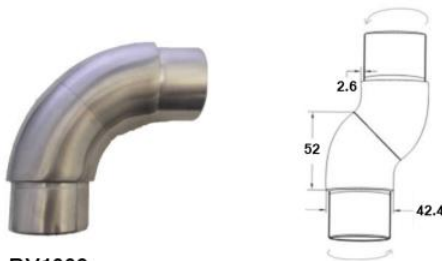

RV1009
Rotatable Bend
304/316

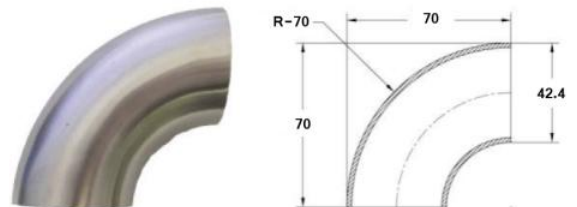

ROB42K
Weldable Elbow
304/316



EVB1009-42.4MM
3 Way Corner Connector
304/316

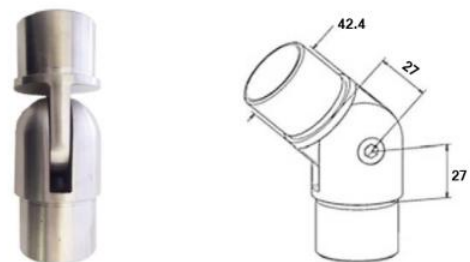

RV1004K-ADJUST-42
Adjustable Angle Changer
304/316



RV1005
90 Degree Sharp Bend
304



RV1007
45/135 Degree Offset Angle
304

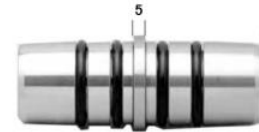

RV1001
Straight Connector
304



RV1005-42.4-Special
PRe-Drilled 90 Degree
Sharp Bend
304



RA1006
Top Rail Insert
304



RA1004
Smooth Adjustable Connector
316

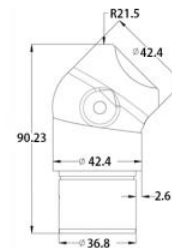

42-Wall-Bracket-316
Side Fix Baluster Clamp
316 Grade - Satin Finish

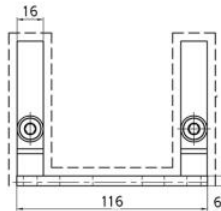

WND1001-42.4
Side Fix Bracket - 40mm Offset
304/316

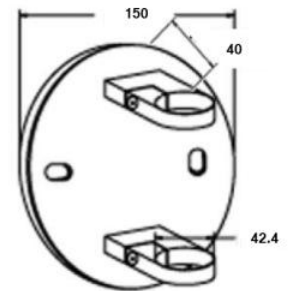

WND1008-42MM-304
Internal/External Corner, 40mm Offset
304/316

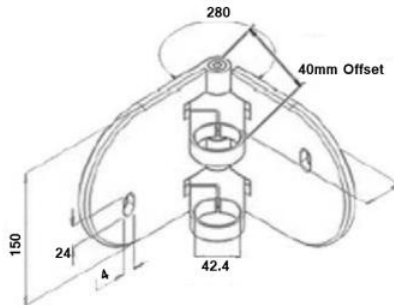

WND1001-42.4-Clip
Clip for Baluster Clamps
304/316

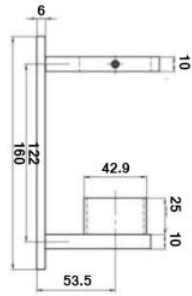

WND1012-42.4
Blank Side Fix, 27mm Offset
316

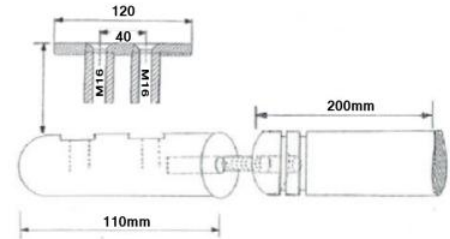

WND1005-42.4-200
Side Fix 30/50/80mm Offset
304/316



BDH1005-100x200
200mm Spigot and
100mm Plate
304/316



BDH1005-120x200
200mm Spigot and
120mm Plate
304/316



BDH1005-100x3-42.4
Smaller 68mm Spigot
x 100mm Plate
304/316



BDH1005-120x3-42.4
Smaller 68mm Spigot
x 120mm Plate
304/316



RHT1005-200-42.4
200mm Solid Spigot
304/316

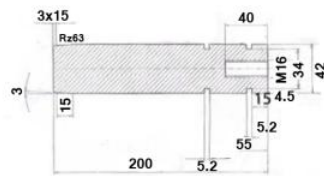

RHT1005-42.4K
68mm High Spigot x M16
304/316

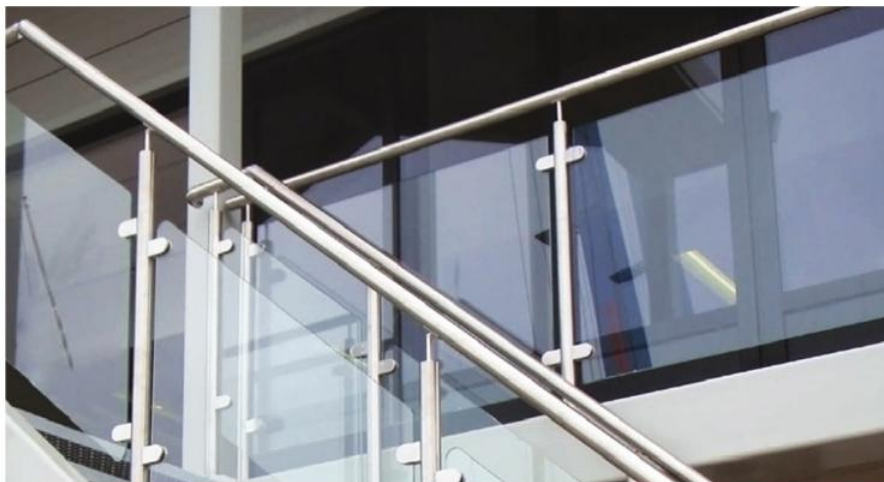
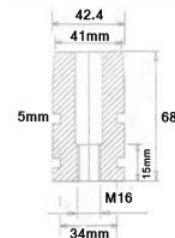

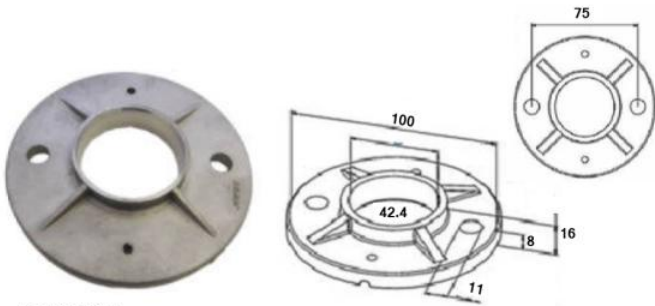

RON1012
Raw Weldable Plate
304/316

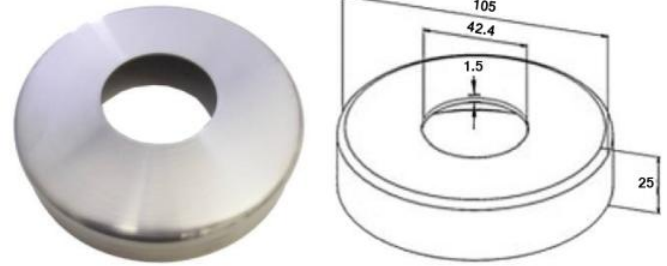

ROS1001
Cover Plate
304/316

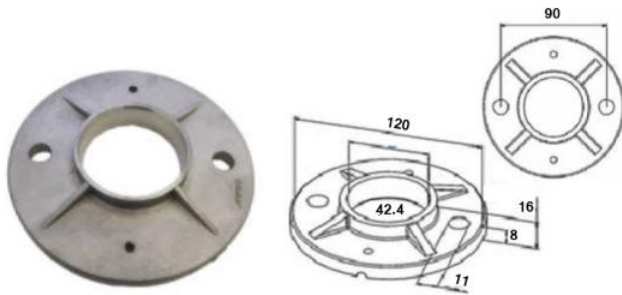

RON1011
Raw Weldable Plate
304/316



ROS1002
Cover Plate
304/316



RON1009-424-316
Plate 105mm x 3 Hole x 80mm c/line
316



ROS1005-42.4x316
Cover Plate 110 x 27mm High
316

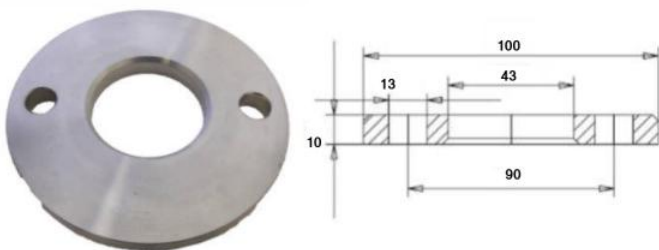

RON1010K-100-43
100mm x 43mm Large Hole
304

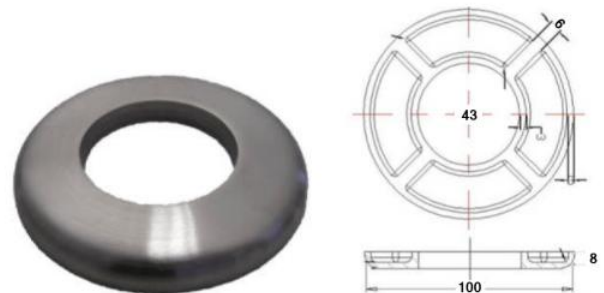

ROS1004-42.4-316
Flat Cover Plate
316



HH1060-M16-42.4
Top Insert
304

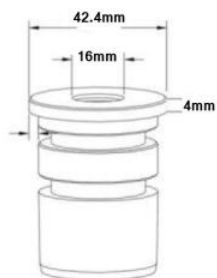

HH1060K-42.4
Flat Top Handrail Insert (M8)
304

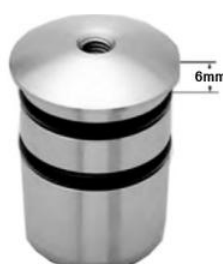

HH1061K-42.4
Convex Top Handrail Insert (M8)
304



HH1062-42.4MM
Dome Head Handrail Insert (M8)
304

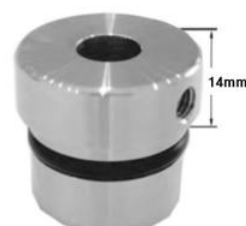

HH1040
Handrail Insert Drilled
15mm Rod and M8
304



HH1011-42.4mm
Handrail Insert 50 Degree
Offset
304



EK1014
Convex Drilled M8 End Cap
316



EK1006-316-42.4
Flat Post End Cap (M8)
304/316



HH1050-42.4
Ball with 43mm Hole
304



BDH1010-50
BDH1010-60-42.4
304/316



BDH1011-50
304



EK1002K-42.4
Flat End Cap
304/316

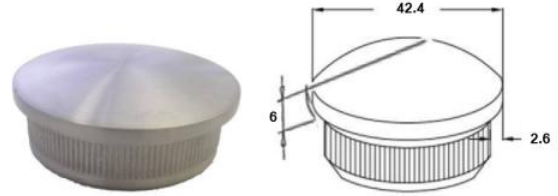

EK1010K-42.4
Convex End Cap
304/316

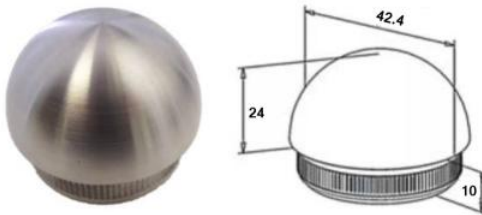

EK1018-42.4K
Dome End Cap
304/316



Wallplate-42.4
Wallplate x 3 Holes
304

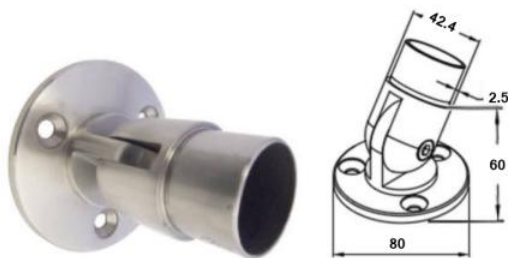

Wallplate-Adj-42
Adjustable wallplate
304/316

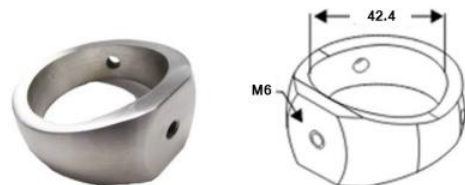

M6-Clip-42.4
Clip with M6 Tap
304/316

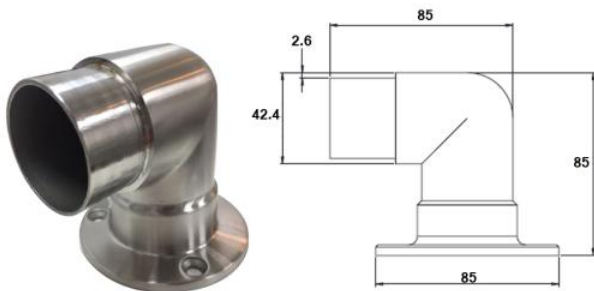

42-RV1003-Wallplate
316 Grade - Satin Finish
Wallplate and 90 Degree Bend

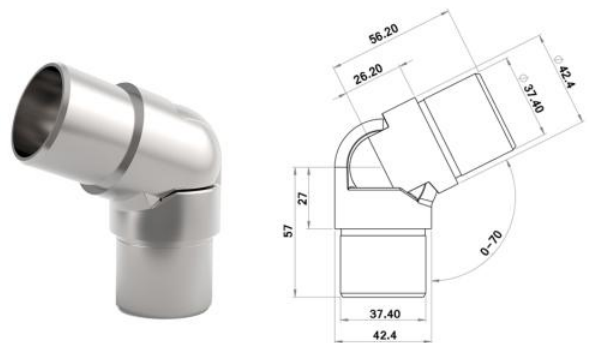

RV1004-Smooth-42.4
316 Grade - Satin Finish
Smooth Adjustable Elbow



HH1005
Straight Complete
304/316



HH1008
Adjustable Complete
304/316

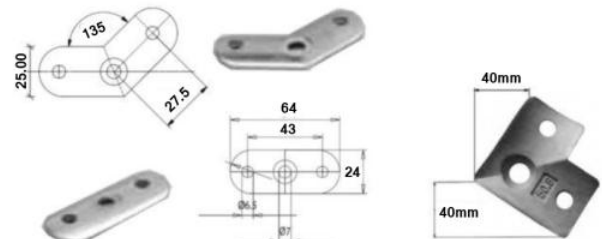

HH1001K-H Straight Saddle 304/316
HH1001-H45 45 Degree Saddle 304/316
HH1001K-Z 90 Degree Saddle 304/316

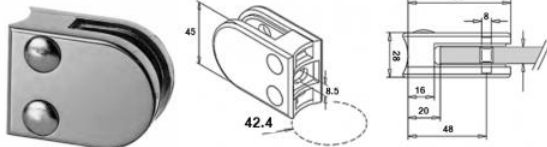

KLH10
D-Shape Glass Clamp

- KLH10R-42.4K-304 (304G Satin, 42.4mm 6-12mm Glass)
- KLH10R-42.4K (316G Satin, 42.4mm 6-12mm Glass)
- KLH10R/M-42.4 (304G Mirror, 42.4mm 6-12mm Glass)
- KLH10R-K-316/M/42.4 (316G Mirror, 42.4mm 6-12mm Glass)
- KLH10U-42.4K (Untreated, 42.4mm 6-12mm Glass)
- KLH10Z-42.4K (Zintec, 42.4mm 6-12mm Glass)

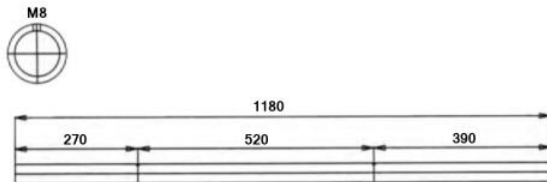

SP1001 - 1180mm High
End Post 2 x M8 pre-drilled holes at 520mm c/c

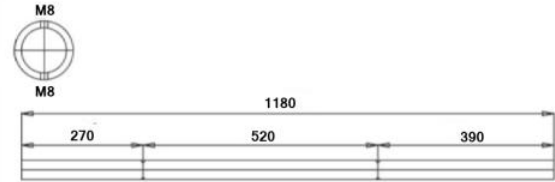

SP1002 - 1180mm High
Mid Post 4 x M8 pre-drilled holes by 180 degrees. Holes at 520mm c/c

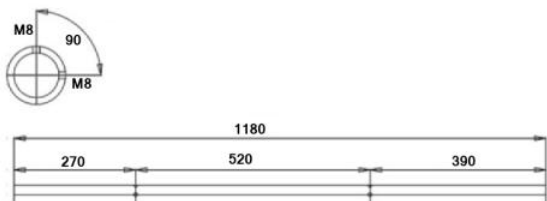

SP1003 - 1180mm High
90 Degree Corner Post 4 x M8 pre-drilled holes at 520mm c/c

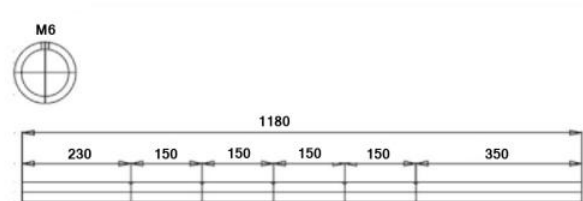

SP1004 - 1180mm High
5 x M6 pre-drilled set at 150mm c/c
Ideal for rod and wire fittings

System Posts are also Available in 304 & 316 Grades and Satin & Mirror Finishes

*Test reports are available upon request

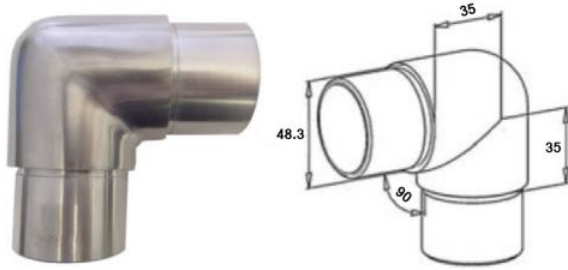

48-RV1003
90 Degree Short Radius Bend
 304/316

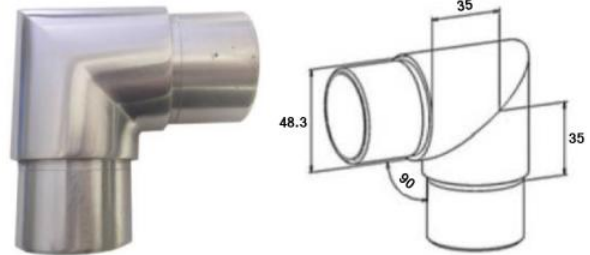

48-RV1005
90 Degree Sharp Bend
 304/316

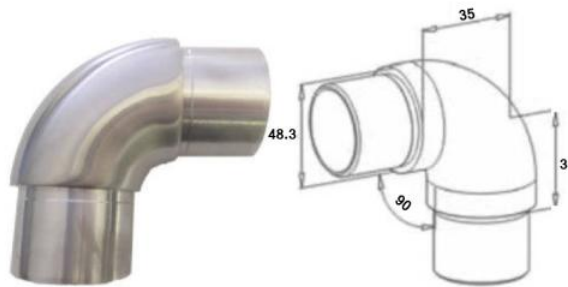

48-RV1008
90 Degree Radius Bend
 304/316

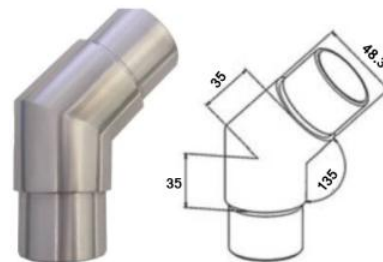

48-RV1007
135/45 Degree Connector
 304/316

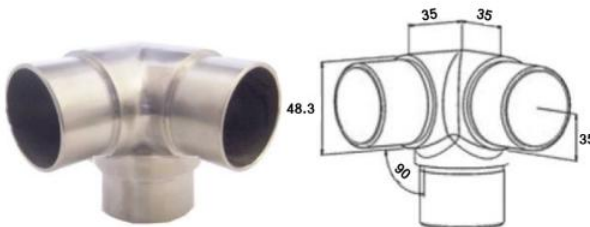

48-EVB1009
3 Way Corner Connector
 304/316

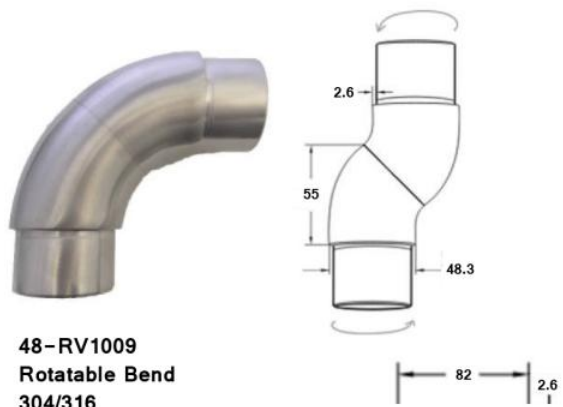

48-RV1009
Rotatable Bend
 304/316

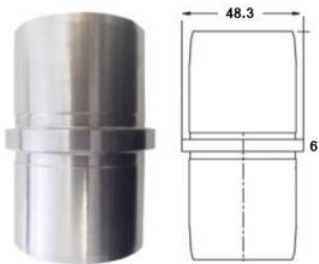

48-RV1001
Tube Connector
 304/316



48-MVB1003
3 Way Connector
 304/316

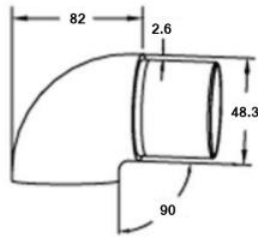

48-RV1018-FLAT
Flat End Scroll
304/316

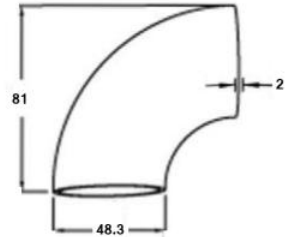
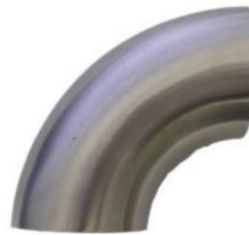

48-ROB
Weldable Elbow x 2mm Wall
304/316

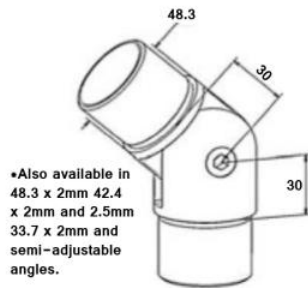

48-RV1004-ADJ
Adjustable Angle Changer
304/316

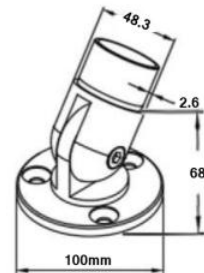

WALLPLATE-ADJ-48.3MM
Adjustable Wall Plate
304/316

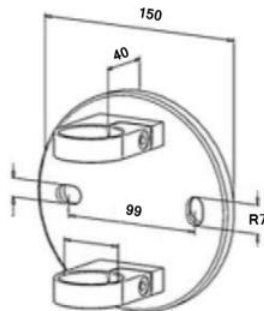

48-WND1001
Side Fix Baluster Clamp x 40mm Offset
304/316

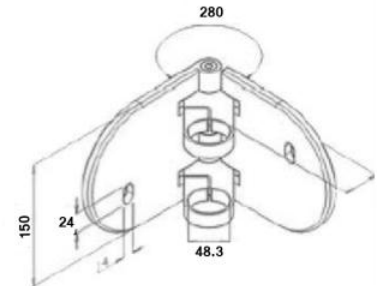

48-WND1008
Internal/External Corner x 40mm Offset
304/316

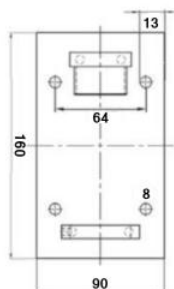

WND1012-48.3-316
Blank Side Fix x 21mm Offset
316

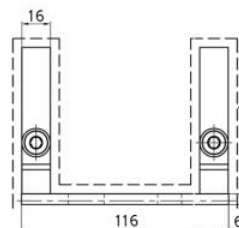

48-Wall-Bracket-316
Small Blank Side Fix
316 Satin



90mm
Hole Centres

WND1005-48-200
Side Fix Bracket 30/50/80mm Offset
304/316

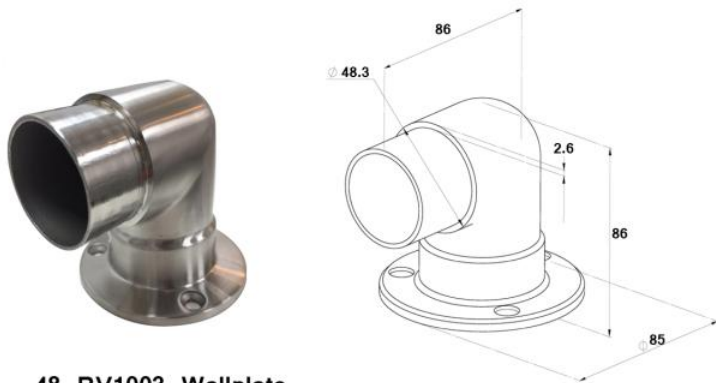

48-RV1003-Wallplate
316 Grade - Satin Finish
Wallplate and 90 Degree Bend

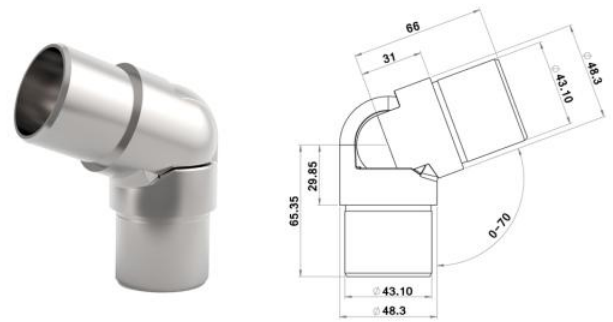

48-RV1004-Smooth
316 Grade - Satin Finish
Smooth Adjustable Bend



BDH1005 (100mm + 120mm)
Available 68mm + 200mm Spigot
304/316 Grade Satin



RHT1005-48.3-68
68mm High Spigot x M16
304/316



48-RA1004
Smooth Adjustable Connector
316

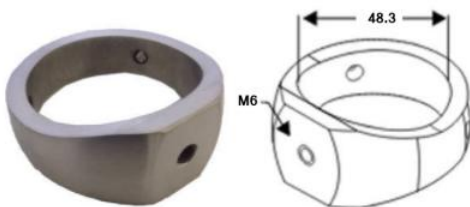

M6-CLIP-48
Clip with M6 Tap
304/316

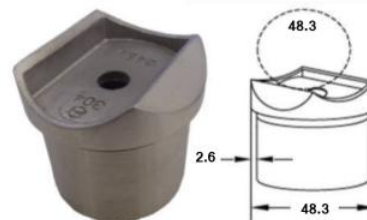

48-RA1006
Adaptor
304/316

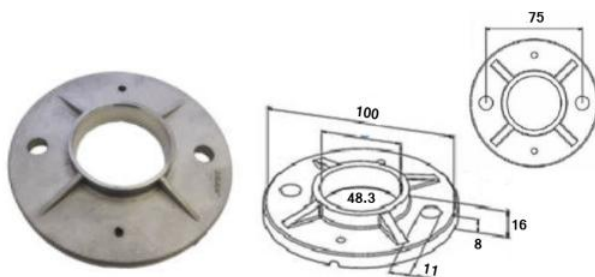

48-RON1012
Raw Weldable Plate
304/316

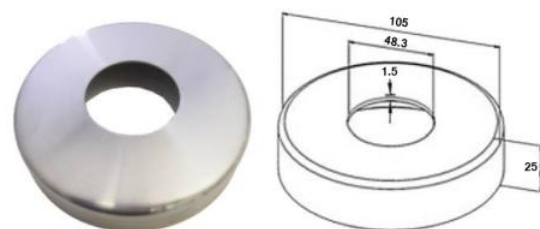

48-ROS1001
Cover Plate
304/316

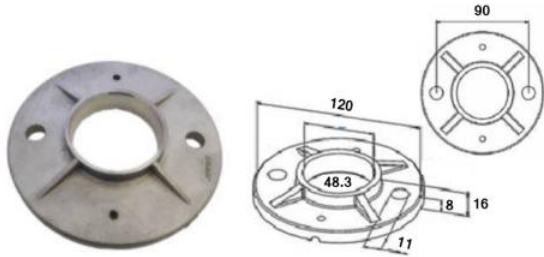

48-RON1011
Raw Weldable Plate
304/316

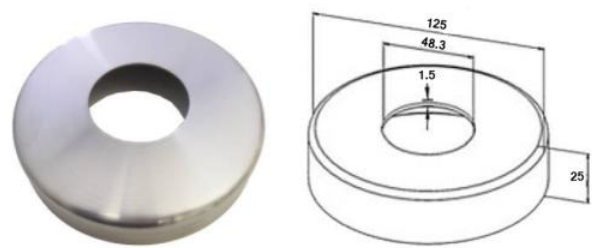

48-ROS1002
Cover Plate
304/316

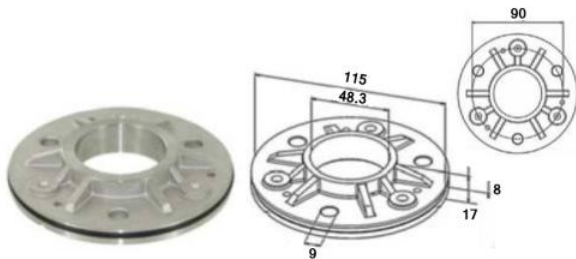

48-RON1009-316
Raw Weldable Plate 115mm x 3 Hole x 90c/line
316



ROS1005-48.3-316
Cover Plate
316

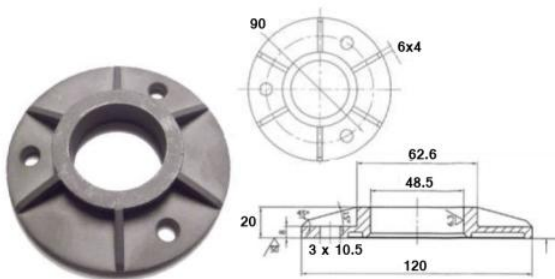

48-RON1016
Raw Weldable Plate 120mm x 3 Hole x 90 c/line
304/316

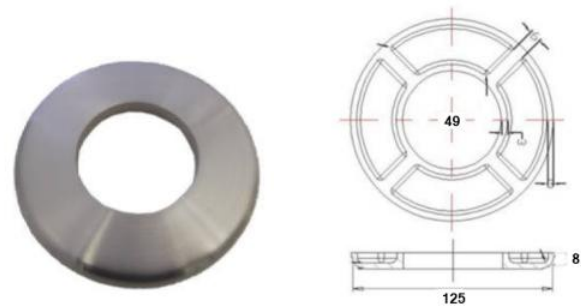

ROS1004-48
Low Cover Plate for Diamond Holes
316

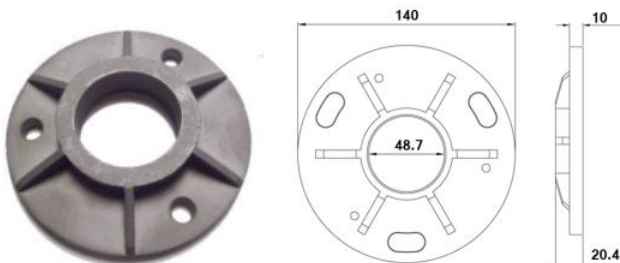

48-RON1017
Raw Weldable Plate 140mm x 3 Hole
316

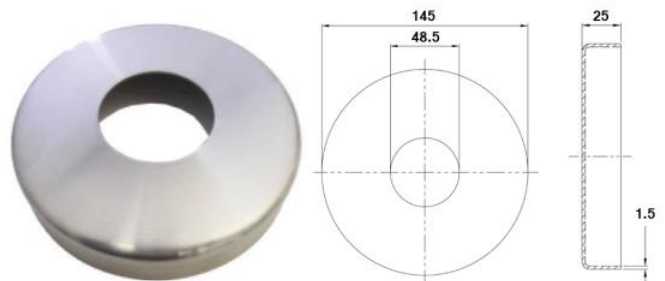

48-ROS1003-145
145mm Cover Plate
316

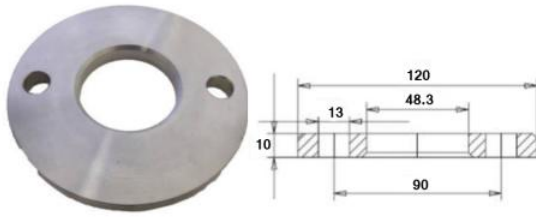

RON1010-120-483
Round Plate with M13 Holes
304/316



48-WALLPLATE
304/316

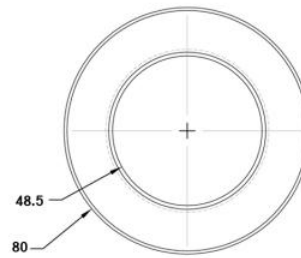
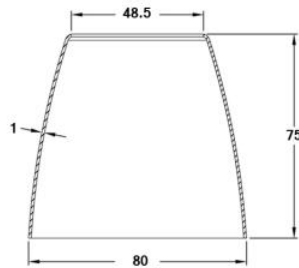

ROS110A-48.3
Asphalt Cover Plate 80 x 75 x 1mm x 48.3mm Tube
316G Satin/Mirror

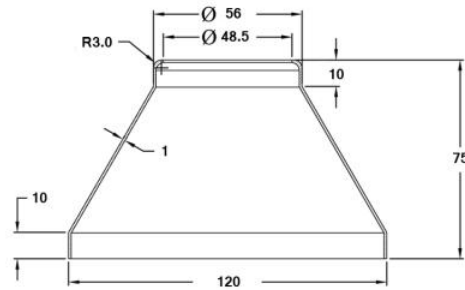

ROS1100B-48.3
Asphalt Cover Plate 120 x 75mm x 48.3mm Tube
316G Satin/Mirror

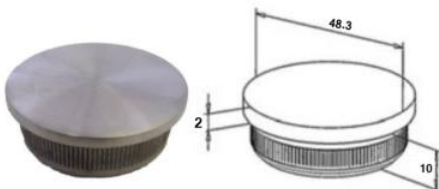

48-EK1002
Flat End Cap
304/316

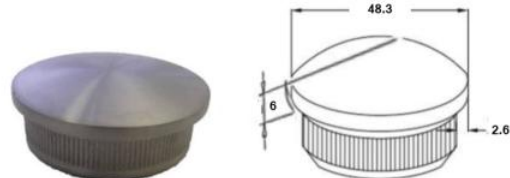

48-EK1010
Convex End Cap
304/316

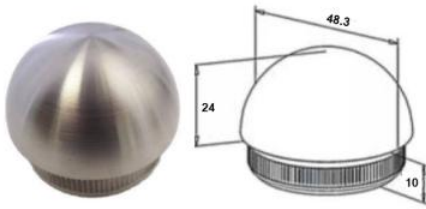

48-EK1018
Dome End Cap
304/316



48-EK1006
Flat End Cap with M8 Hole
304/316



48-EK1014
Convex End Cap with M8 Hole
304/316



48-HH1005
Straight Neck (In part form)
304/316



48-HH1008
Adjustable Neck (In part form)
304/316

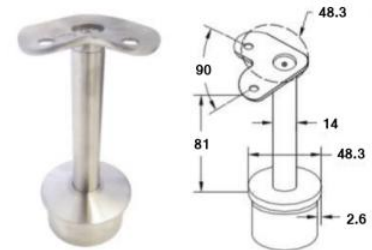

48-HH1005-90D
90 Degree Saddle (In part form)
304/316



48-HH1005-135
135 Degree Saddle (In part form)
304/316

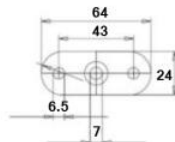

HH1001K-H-50.8
Straight Saddle
304/316

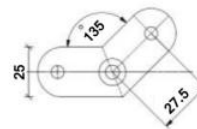

HH1001K-45-50.8
45 Degree Angle Saddle
304/316

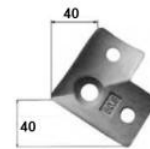

HH1001K-Z-50.8
90 Degree Angle Saddle
30/316



RON1014K-48.3-316
Weldable Plate - Satin Polished x 320
316

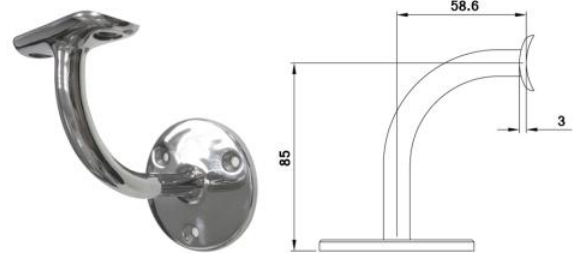
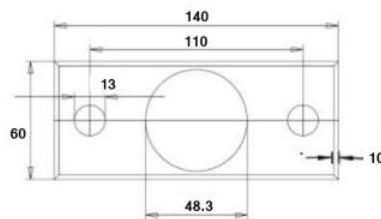

WS172 - 85mm Offset - 316 (Satin)
48.3mm Saddle, 85mm Offset
316 Satin

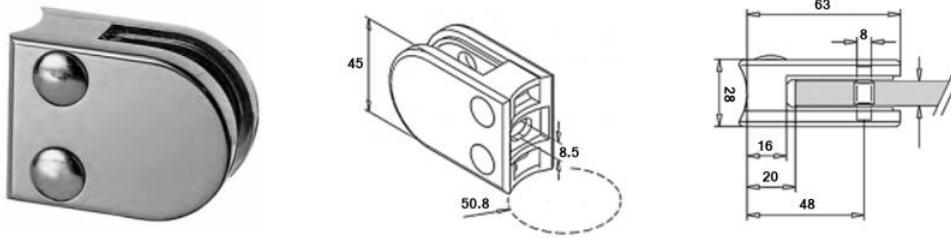

KLH10R-K-304 (304G Satin, 48.3mm 6-12mm Glass)
 KLH10R-48.3K (316G Satin, 48.3mm 6-12mm Glass)
 KLH10R/M-48.3 (304G Mirror, 48.3mm 6-12mm Glass)
 KLH10R-K-316M (316G Mirror, 48.3mm 6-12mm Glass)
 KLH10U-48.3K (Untreated, 48.3mm 6-12mm Glass)
 KLH10Z-48.3K (Zintec, 48.3mm 6-12mm Glass)

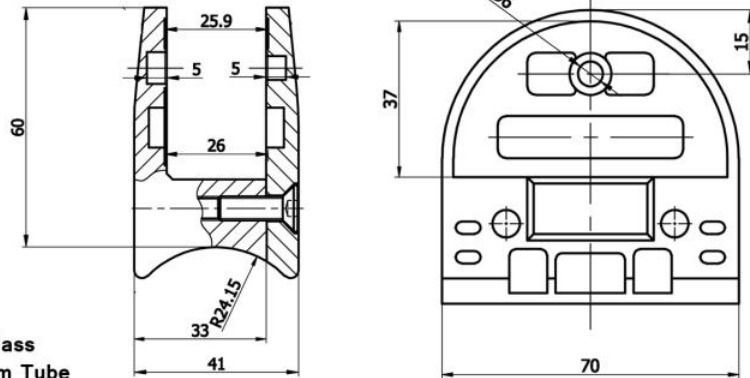
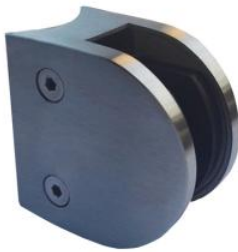

KLH21.5MM-R-316
 Suitable for 15, 17.52, 19 and 21.52mm Glass
 316 Grade - Satin / Mirror - 48.3 / 50.8mm Tube
 (Also available with a 'Flat Back')

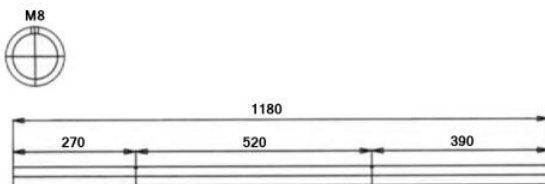

SP1001 - 1180mm High
 End Post 2 x M8 pre-drilled holes at 520mm c/c

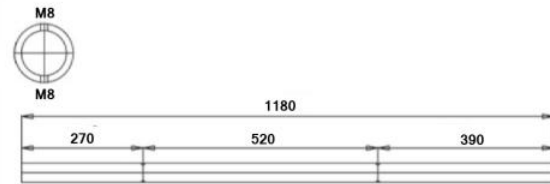

SP1002 - 1180mm High
 Mid Post 4 x M8 pre-drilled holes by 180 degrees. Holes at 520mm c/c

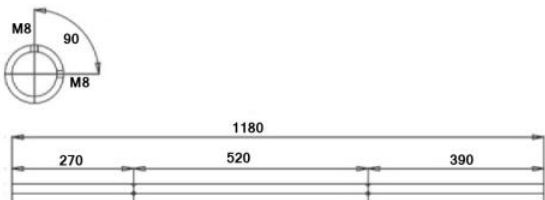

SP1003 - 1180mm High
 90 Degree Corner Post 4 x M8 pre-drilled holes at 520mm c/c

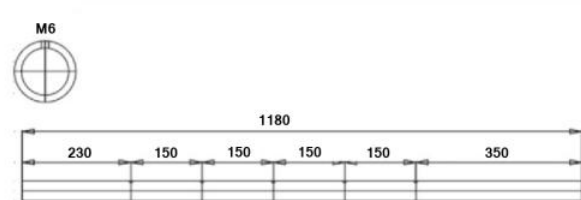

SP1004 - 1180mm High
 5 x M6 pre-drilled set at 150mm c/c
 Ideal for rod and wire fittings

System Posts are also Available in 304 & 316 Grades and Satin & Mirror Finishes

*Test reports are available upon request

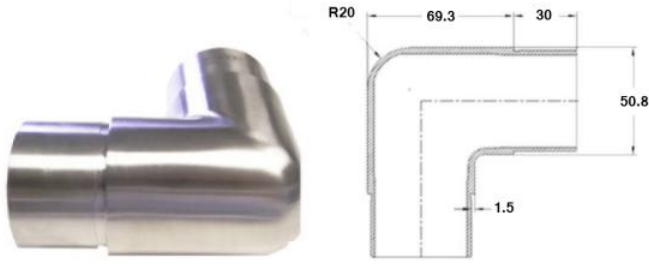

RV1003-50.8x1.5mm
Short Radius Bend
316

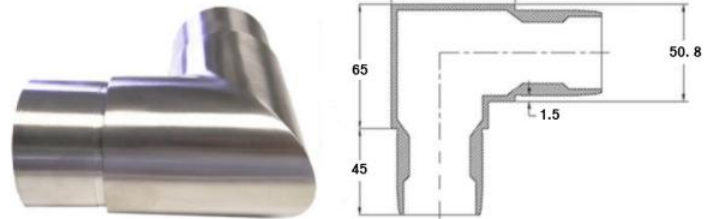

RV1005-50.8x1.5mm
Sharp Bend
316

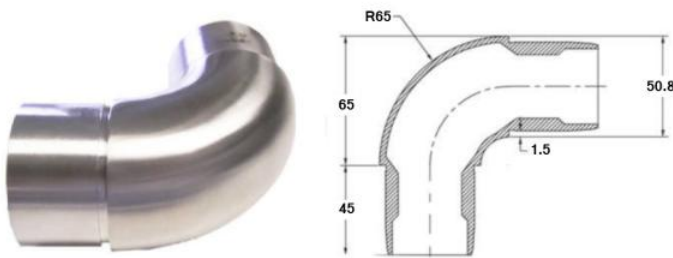

RV1008-50.8x1.5mm
Radius Bend
316

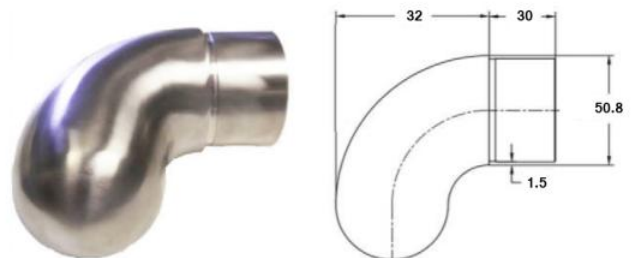

RV1018-50.8x1.5mm
Rounded End Scroll
316

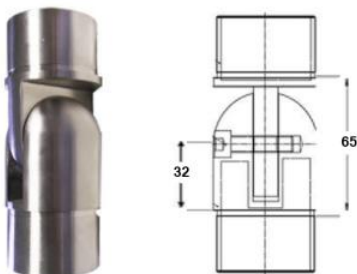

RV1004-ADJ-50.8x1.5mm
Adjustable Angle Changer
316



RV1001-50.8x1.5mm
Straight Connector
316

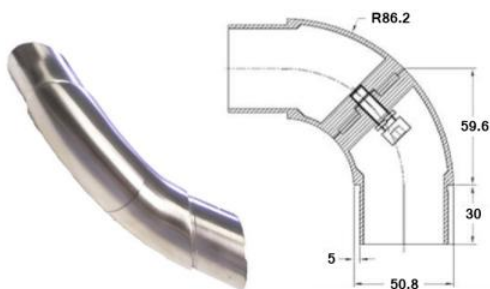

RV1009-50.8x1.5mm
Rotatable Bend
316



RO1001-50.8
Tube x 1.5mm Satin/Mirror
304/316

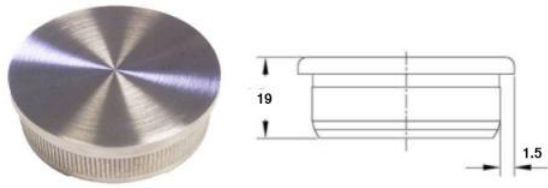

EK1002-50.8x1.5mm
Flat End Cap
316

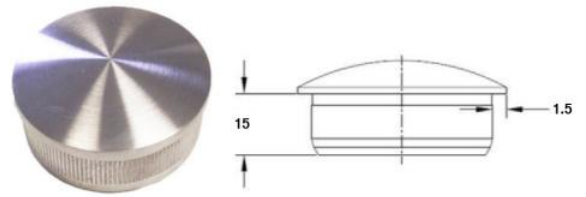

EK1010-50.8x1.5mm
Convex End Cap
316

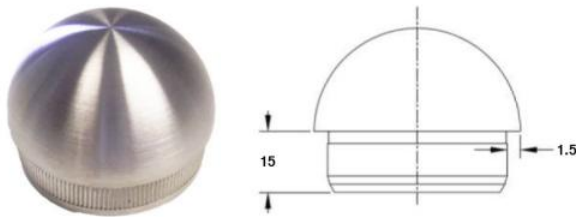

EK1018-50.8x1.5mm
Dome End Cap
316



*Test reports are available upon request

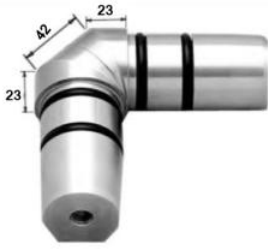

RV1006/50.8
Adjustable Angle Bend
316



RV1008-50.8
90 Degree Radius Bend
304/316

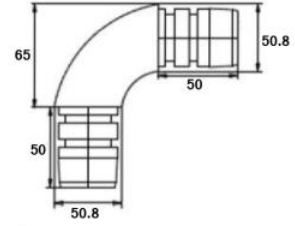

RV1005-50.8-Special
Pre-Drilled 90 Degree Sharp Bend for Saddle
316

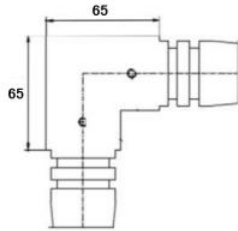

RV1005-50.8
90 Degree Sharp Bend
304/316

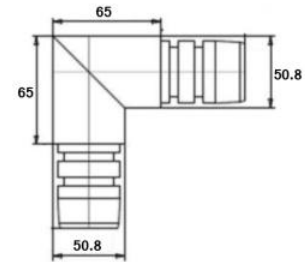

RV1007/50.8
45/135 Degree Set Angle Connector
316

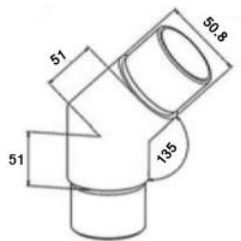

RV1001/50.8
Straight Connector
304/316

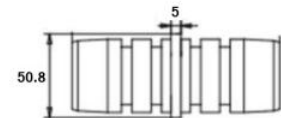

RV1009-50.8
Rotatable Elbow
316

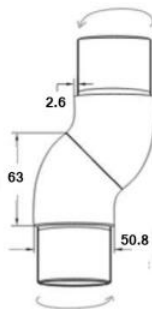

RV1004K-Adjust-50.8
Adjustable Angle Changer
316

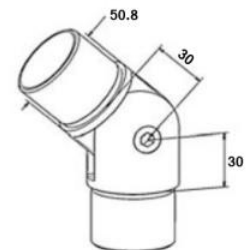

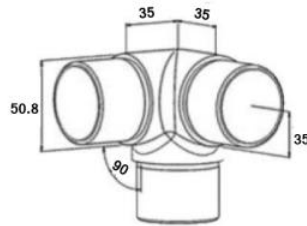

EVB1009K-50.8
3 Way Hollow Corner
316

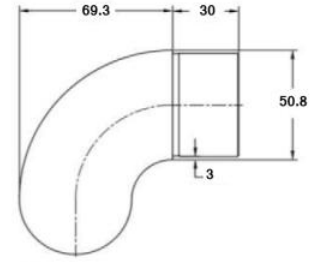

RV1018-50.8K-Rounded
Rounded End Scroll
304/316

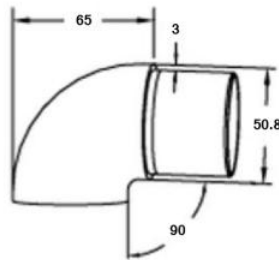

RV1018
Blank End Scroll
316

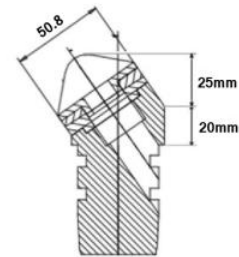

RA1004-35-316-50.8
30-40 Degree (+/-5) Insert
304/316

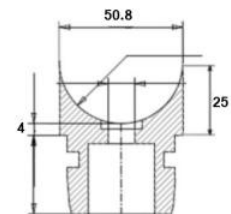
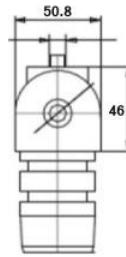

RA1011-50.8
0-40Degree Adjustable Angle
304

GLS1001K-316-50.8
Adjustable Angle Insert

RA1006/50.8
Adaptor 50.8 Ali Insert
304/316

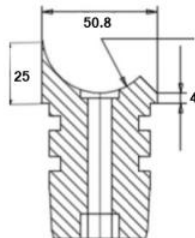

RA1005/50.8
90 Degree Corner Insert
Outlet Adaptor
304

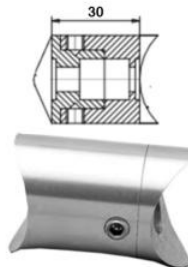

RA1010
50/50mm Connector
304

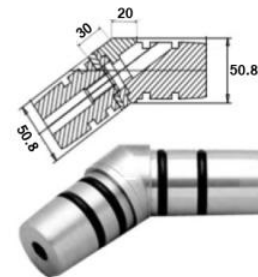

RV1004-25-316-50.8
20-30 Degree Angle Changer

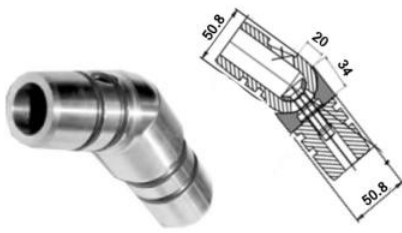

RV1011-50.8
0-40 Degree Angle Changer



ROB-50.8K
Weldable Elbow x 2mm
304/316

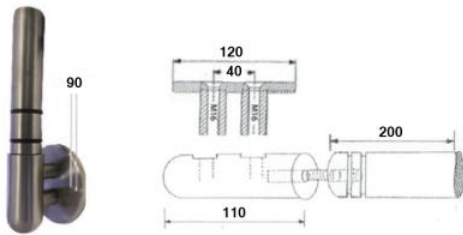
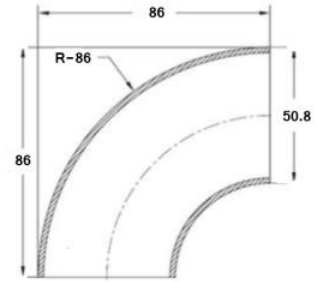

WND1005-30/50/80
30/50/80mm Offset
304/316

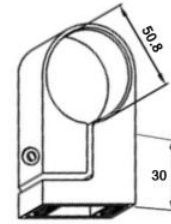

WND1001-CLIP
Offset different to complete unit
304/316

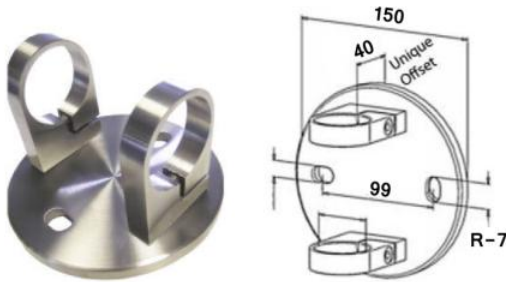

WND1001-50.8
40mm Offset Side Fix Bracket
304/316

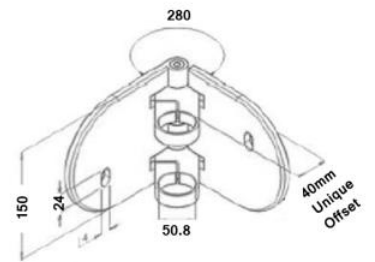

WND1008-50.8
40mm Offset Internal/External Corner
304/316



BDH1005/100/50.8
200mm Spigot and
100mm Plate - 3 x
M13 Fixing Holes
304/316



BDH1005/120/50.8
200mm Spigot and
120mm Plate - 3 x
M13 Fixing Holes
304/316



BDH1005x100mm
Smaller 68mm
Spigot x 100mm
Plate - 3 x M13
Fixing Holes
304/316



BDH1005x120mm
Smaller 68mm
Spigot x 120mm
Plate - 3 x M13
Fixing Holes
304/316



RHT1005-316x68mm
68mm High Spigot x M16

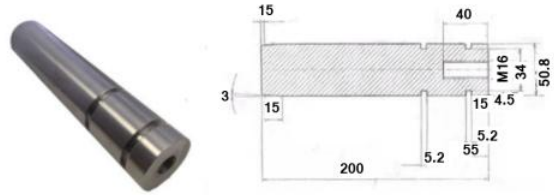

RHT1005K-200-50.8
200mm Solid Spigot
x M16
304/316



ROS1001-50.8
Cover Plate
304/316

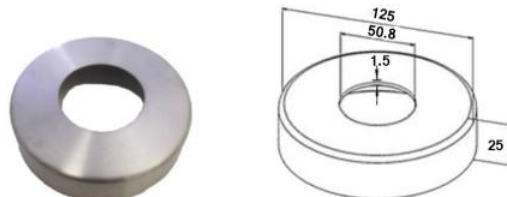

ROS1002-50.8
Cover Plate
304/316

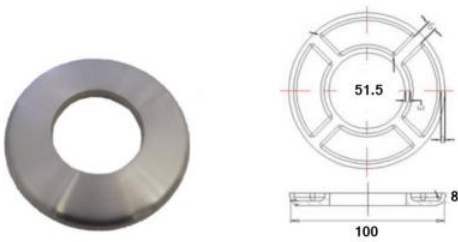

ROS1004-50.8-316
Diamond Hole Cover Plate
316

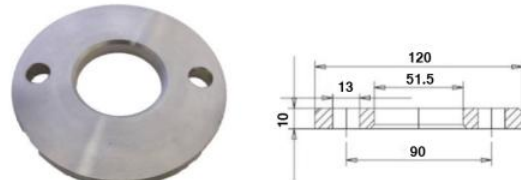

RON1010/50.8
Weldable Plate
304/316

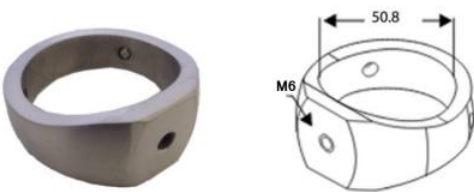

M6-CLIP
Clip with 2 x M6 Tapped Holes
304/316



BDH1010-60-316
60mm Plate x 50.8mm
Ali Insert
304/316



BDH1011-50.8mm
50.8 x 60mm Through
Fix - Ali
304



HH1011-304-50.8
Handrail Insert - 50 Degrees
Offset with M8
304



HH1061-50.8
Convex Top Handrail
Insert with M8
304/316



HH1060K-50.8
Flat Top Handrail
Insert With M8
304/316



HH1040-304-50.8
Handrail Support
Drilled to Take 15mm
Rod and M8
304



HH1050-50.8mm
Ball with 50mm
Hole
304



Sample Assembly for
Open Treads
304/316



RO1001-50.8
x 3mm Wall Tube
304/316
Satin/Mirror

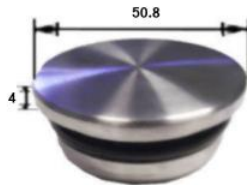

EK1002-50.8
Flat End Cap (Solid)
304/316



EK1010K-50.8
Convex End Cap (Solid)
304/316



EK1018-50.8
Dome End Cap (Solid)
304/316

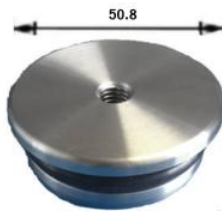

EK1006/50.8
Flat End Cap (Solid)
304/316
Drilled M8

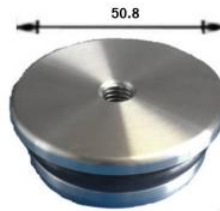

EK1014-50.8
Convex Drilled M8 End Cap
304/316

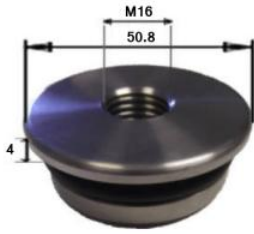

EK1006-304-50.8
Flat Drilled M16 End Cap
304/316



HH1005-50.8mm
Straight Complete
Bung/Stem/Saddle
304/316



HH1008-50.8mm
Adjustable Complete
Bung/Stem/Saddle
304/316



HH1003Y - 75mm Offset - 304/316
HH1003K - 90mm Offset - 304/316

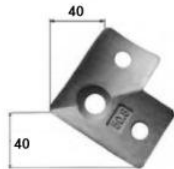

HH1001K-Z-50.8
90 Deg Angle Saddle
316

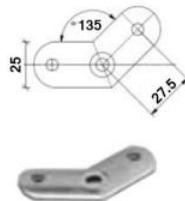

HH1001K-45-50.8
45 Deg Angle Saddle
316

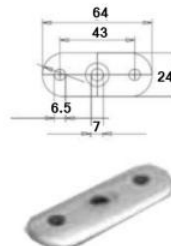

HH1001K-H-50.8
Straight Saddle
304/316



RON1014-140
Weldable Plate
304/316

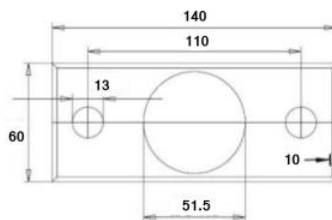

WALLPLATE-50.8
Wall Plate with 3 x M6 Fixing Holes
316

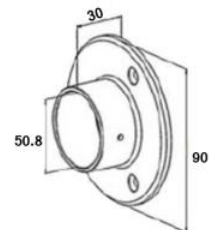

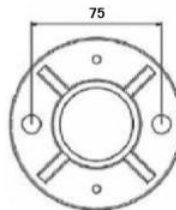
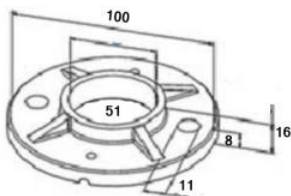

RON1012-50.8
Raw Weldable Plate
304/316

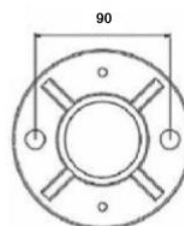
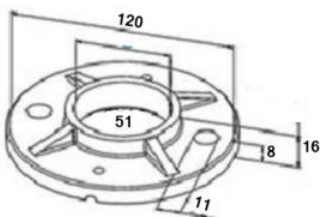

RON1011-50.8
Raw Weldable Plate
304/316

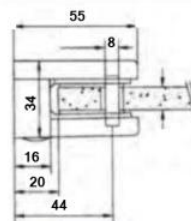
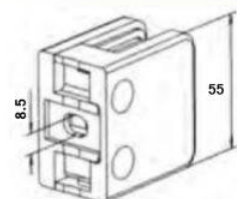

KLH12R-50.8
Square Glass Clamp 55 x 55mm
304/316



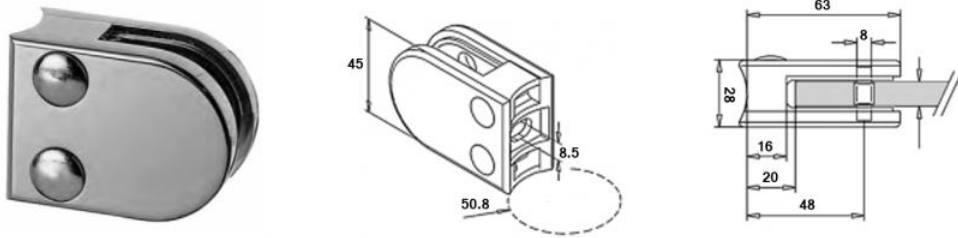

- KLH10R-K-304 (304G Satin, 50.8mm 6-12mm Glass)
- KLH10R-50.8K (316G Satin, 50.8mm 6-12mm Glass)
- KLH10R/M-50.8 (304G Mirror, 50.8mm 6-12mm Glass)
- KLH10R-K-316M (316G Mirror, 50.8mm 6-12mm Glass)
- KLH10U-50.8K (Untreated, 50.8mm 6-12mm Glass)
- KLH10Z-50.8(K) (Zintec, 50.8mm 6-12mm Glass)

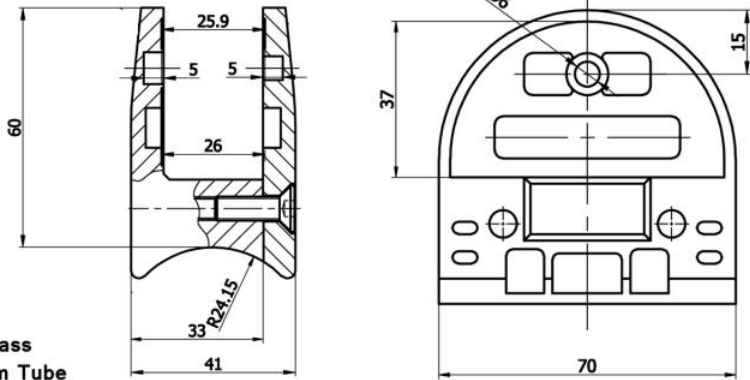
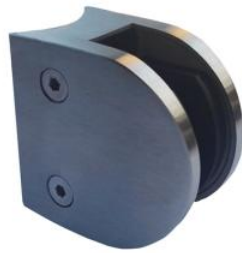

KLH21.5MM-R-316
 Suitable for 15, 17.52, 19 and 21.52mm Glass
 316 Grade - Satin / Mirror - 48.3 / 50.8mm Tube
 (Also available with a 'Flat Back')

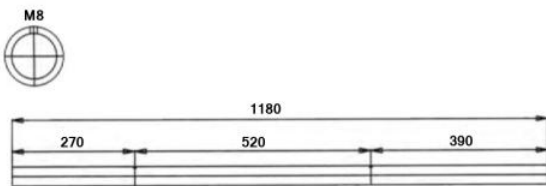

SP1001 - 1180mm High
 End Post 2 x M8 pre-drilled holes at 520mm c/c

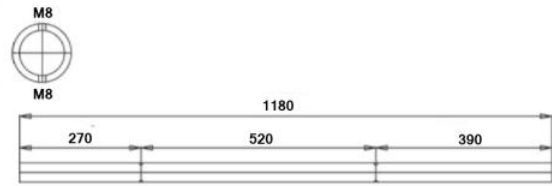

SP1002 - 1180mm High
 Mid Post 4 x M8 pre-drilled holes by 180 degrees. Holes at 520mm c/c

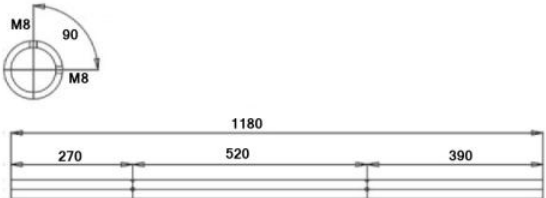

SP1003 - 1180mm High
 90 Degree Corner Post 4 x M8 pre-drilled holes at 520mm c/c

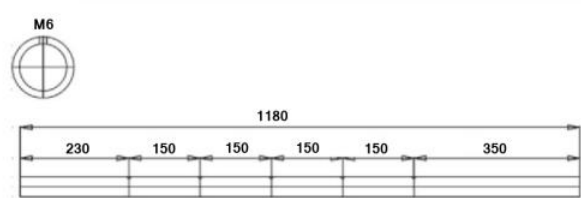

SP1004 - 1180mm High
 5 x M6 pre-drilled set at 150mm c/c
 Ideal for rod and wire fittings

System Posts are also Available in 304 & 316 Grades and Satin & Mirror Finishes

*Test reports are available upon request

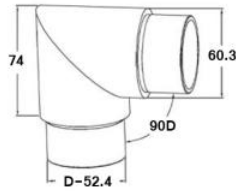

RV1005-60.3-316
90 Degree Sharp Ben

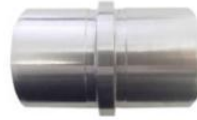

RV1001-60.3-316
Straight Tube Connector

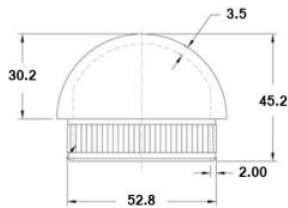

W270-4mm
Dome End Cap

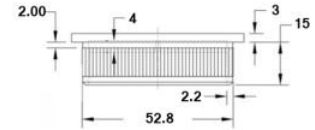

W268-4mm
Flat End Cap

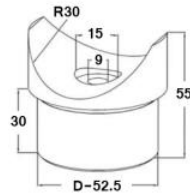

RA1006-60.3-316
Top Rail Insert

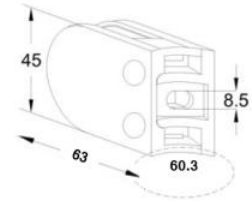

KLH10D-60.3
Glass Clamp 304/316G - Satin
Rubbers also available for 6/8/12mm Glass

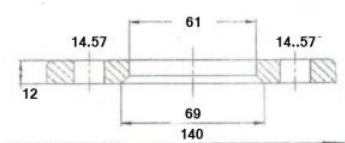

RON140-12
Weldable Base Plate
304/316

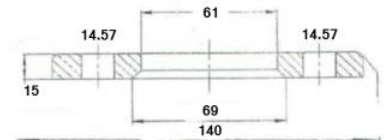

RON140-15
Weldable Base Plate
304/316

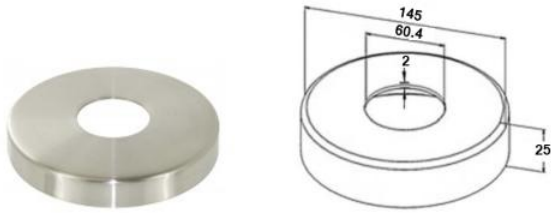

ROS140-61
Satin Cover Plate
304/316

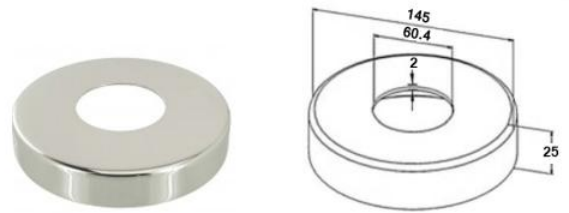

ROS140-61-Mirror
Mirrored Cover Plate (316)

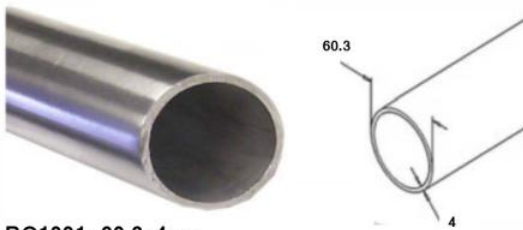

RO1001-60.3x4mm
(316G Satin 320Grit)

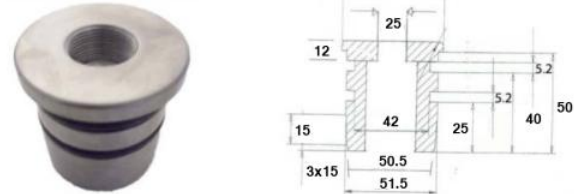

HH1060-60.3-316
Top Insert with 25mm threaded hole
316



HH1060-60.3-M8
Top Insert with M8 threaded hole
316

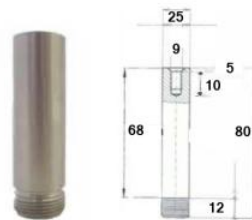

HH1002H-25-60.3
Fixed Stem - 316



GLS1002K-60.3-316
Stem with Swivel Neck

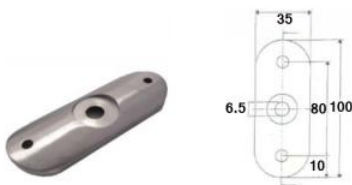

HH1001K-60.3-316
Straight Saddle



HH1001K-Z-60.3-316
90 Degree Corner Saddle



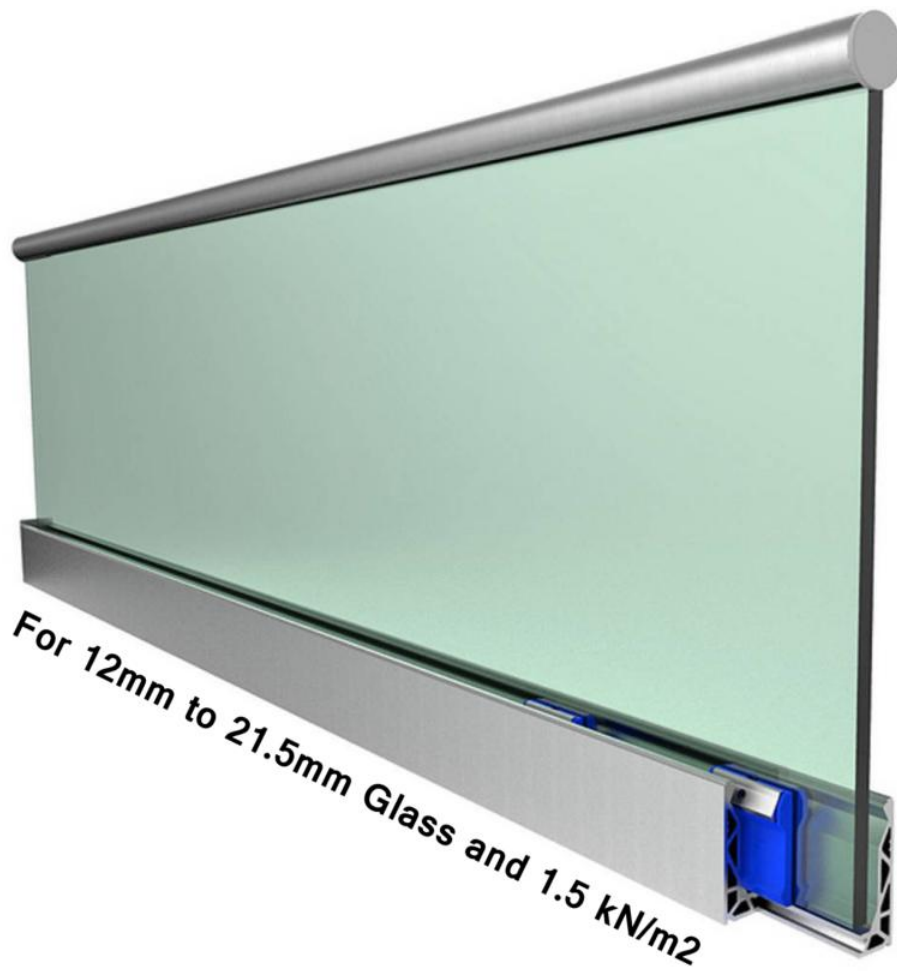



KT-Top-Floor-Channel
3m Lengths (p/p/m)
Anodized Aluminium



KT-Glass-Kit
3m Packs - P/P/M
Wedges / Bolts/ Bars/ Rubbers

KT-12MMGLASS-KIT
KT-13.5MMGLASS-KIT
KT-15MMGLASS-KIT
KT-17.5MMGLASS-KIT
KT-19MMGLASS-KIT
KT-21.5MMGLASS-KIT

Each glass kit included relevant top-bead rubber



KT-Bead-Strip
3m Lengths (p/p/m)
Anodized Aluminium

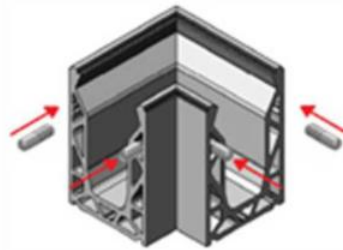

KT-90D-CNR-TOP-CH
90 Degree Corner
Supplied with Dowels



KT-Spanner
(Recommended 2 per project)



KT-EndCap-TopCh



KT-Dowel-Connect
(Pack of 2)



KT-Drainage-Block



KT-EndCap-PushFit
4mm Thick
Push Fit (with dowels)



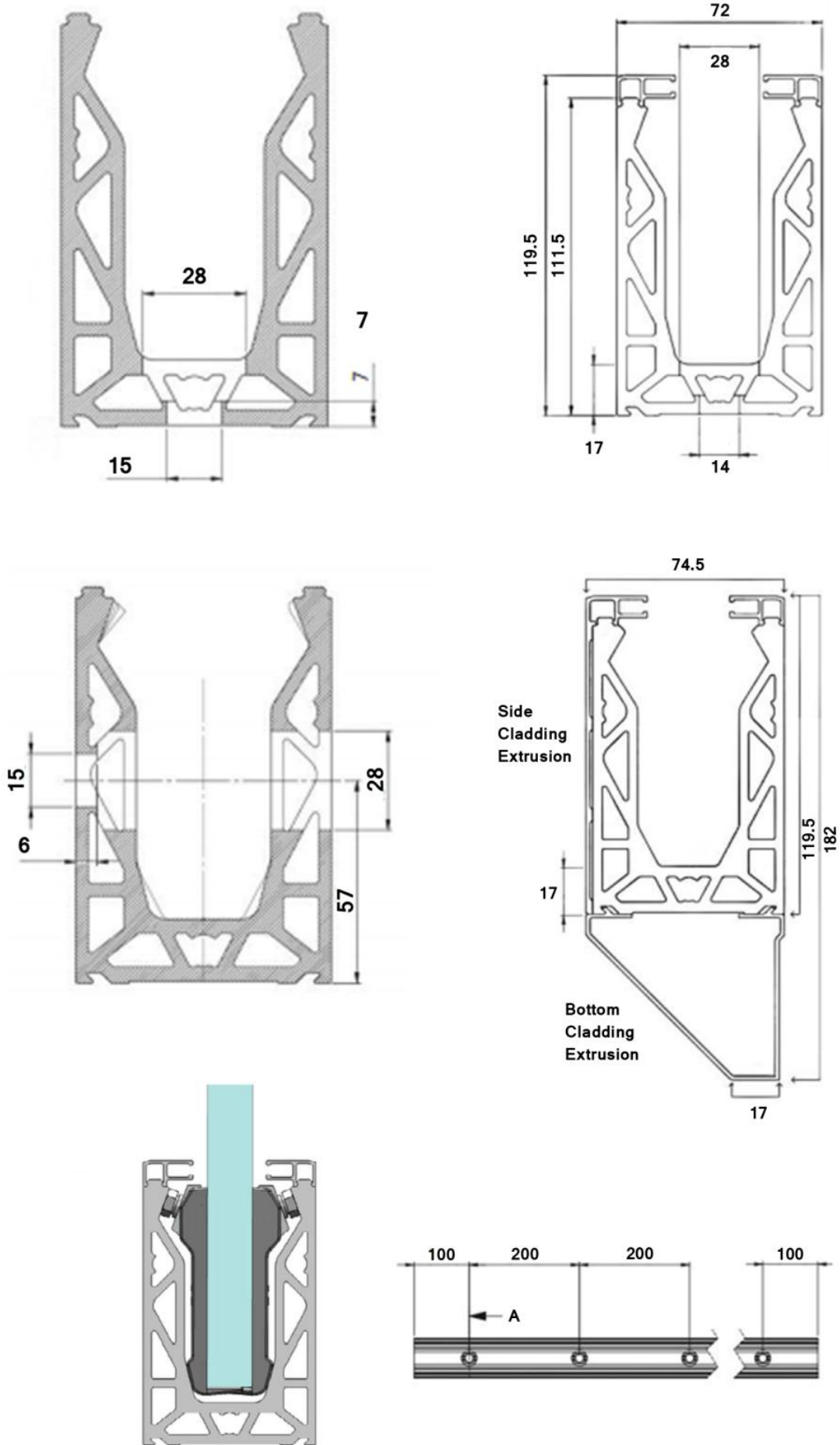

Base Fixed onto Concrete

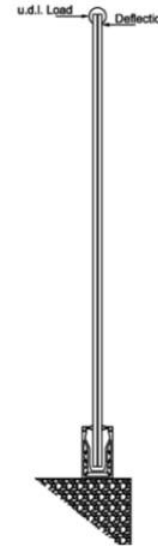
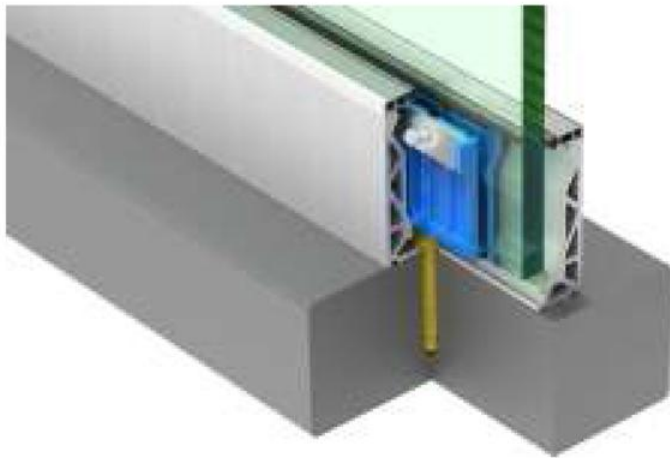

Fixing and test Method

Glass Type	Horizontal U.D.L. Kn/M	Height mm	Deflection mm
15mm Toughened, Heat Soaked	0.74	1120	18.20
15mm Toughened, Heat Soaked	0.98	1120	25.03
19mm Toughened, Heat Soaked	0.74	1095	9.93
19mm Toughened, Heat Soaked	1.00	1095	14.30
19mm Toughened, Heat Soaked	1.50	1095	21.80
19mm Toughened, Heat Soaked	1.63	1095	25.00
21.5mm EVA Laminated Toughened, Heat Soaked	0.74	1093	15.45
21.5mm EVA Laminated Toughened, Heat Soaked	1.07	1093	25.00
21.5mm Rigid Laminated Toughened, Heat Soaked	0.74	1116	9.60
21.5mm Rigid Laminated Toughened, Heat Soaked	1.00	1116	13.68
21.5mm Rigid Laminated Toughened, Heat Soaked	1.50	1116	22.70
21.5mm Rigid Laminated Toughened, Heat Soaked	1.56	1116	25.00

Base Fixed Onto Steel

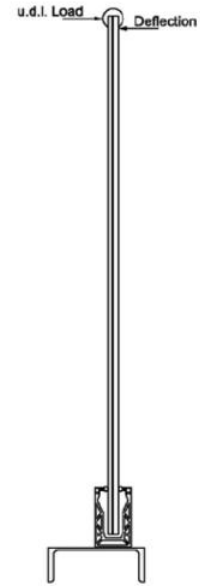
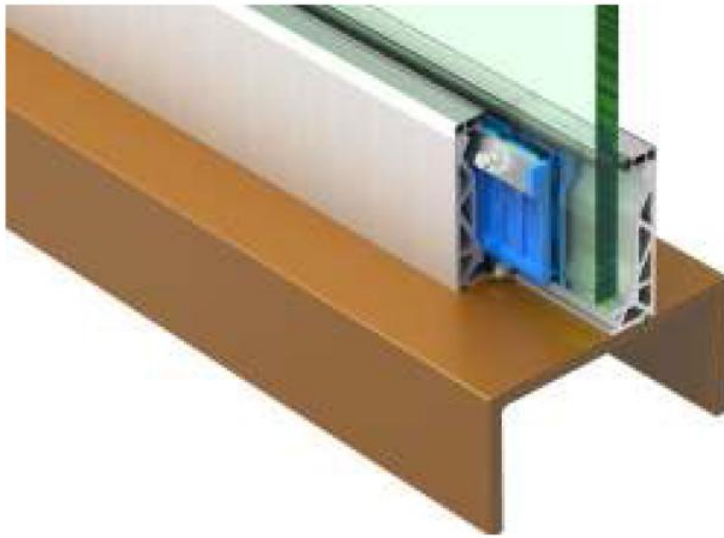

Fixing and Test Method

Glass Type	Horizontal U.D.L. kN/m	Height mm	Deflection mm
15mm Toughened Heat Soaked	0.36	1118	9.10
15mm Toughened Heat soaked	0.74	1118	19.71
15mm Toughened Heat Soaked	0.85	1118	25.00
19mm Toughened Heat Soaked	0.74	1097	10.21
19mm Toughened Heat Soaked	1.50	1097	23.76
21.5mm EVA Laminated Toughened Heat Soaked	0.36	1098	7.12
21.5mm EVA Laminated Toughened Heat Soaked	0.74	1098	15.82
21.5mm EVA Laminated Toughened Heat Soaked	1.00	1098	22.64
21.5mm EVA Laminated Toughened Heat Soaked	1.06	1098	25.00
21.5mm Rigid Laminated Toughened Heat Soaked	0.36	1118	4.71
21.5mm Rigid Laminated Toughened Heat Soaked	0.74	1118	10.50
21.5mm Rigid Laminated Toughened Heat Soaked	1.00	1118	14.77
21.5mm Rigid Laminated Toughened Heat Soaked	1.50	1118	22.46
21.5mm Rigid Laminated Toughened Heat Soaked	1.60	1118	25.18

KT-Bal-Seal-Kit

*Includes 15 x Balcony Seal Drainage Blocks + 2 x Tubes of Sealant

This is a revolutionary product that provides a solution to both water drainage and waterproofing on a balcony installation. It comprises of drain blocks that sit underneath the balustrade channel. Notches on the top side of the drain blocks locate into the rebates of the channel, locking it into position before the system is bolt-fixed to the substrate through each drain block. The gaps between the drain block are your water drainage channels. The drain blocks are subsequently filled with sealant to create a fully waterproofed balustrade installation.

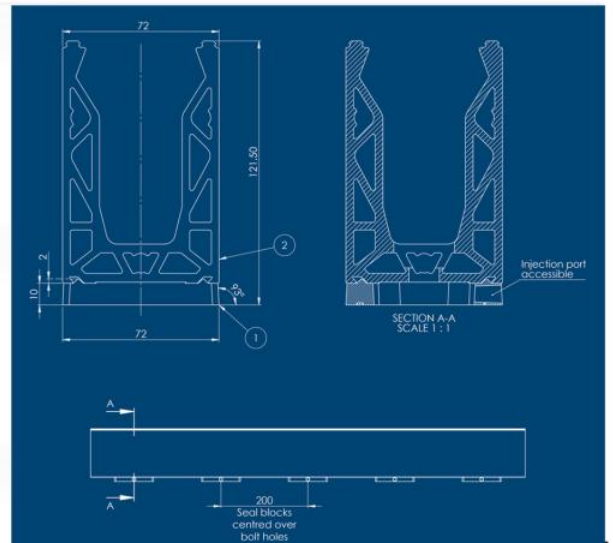
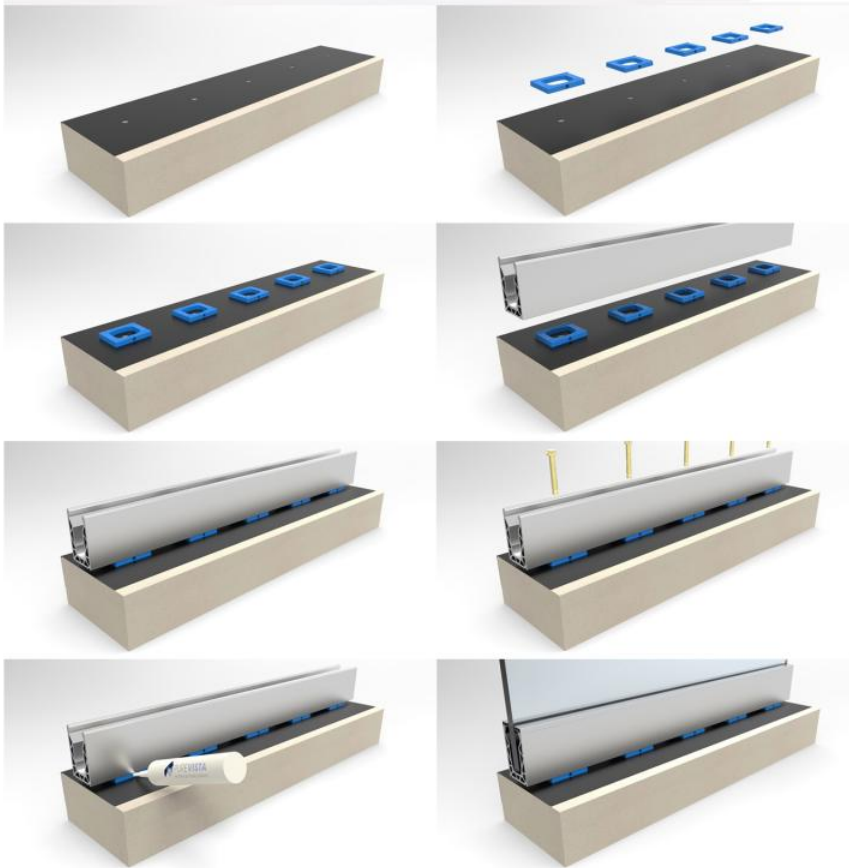



For 12mm to 21.5mm Glass and 0.74kN/m²



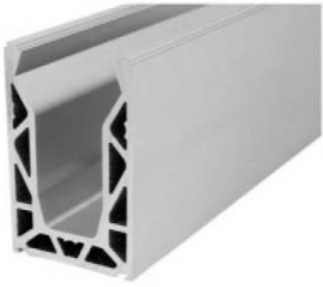

KT-Side-Fix-Channel
3m Lengths (p/pm)
Anodized Aluminium



KT-12MMGLASS-KIT
KT-13.5MMGLASS-KIT
KT-15MMGLASS-KIT
KT-17.5MMGLASS-KIT
KT-19MMGLASS-KIT
KT-21.5MMGLASS-KIT

Each glass kit
included relevant
top-bead rubber

KT-Glass-Kit
3m Packs - P/P/M
Wedges / Bolts/ Bars/ Rubbers



KT-Side-Cladding
3m Lengths (p/pm)



KT-Bottom-Cladding
3m Lengths (p/pm)



KT-Bead-Strip
3m Lengths (p/p/m)
Anodized Aluminium



KT-Spanner
(Recommended 2 per project)



KT-EndCap-Side-L/H



KT-EndCap-Side-R/H



KT-Dowel-Connect
(Pack of 2)



Side Fixed Onto Concrete

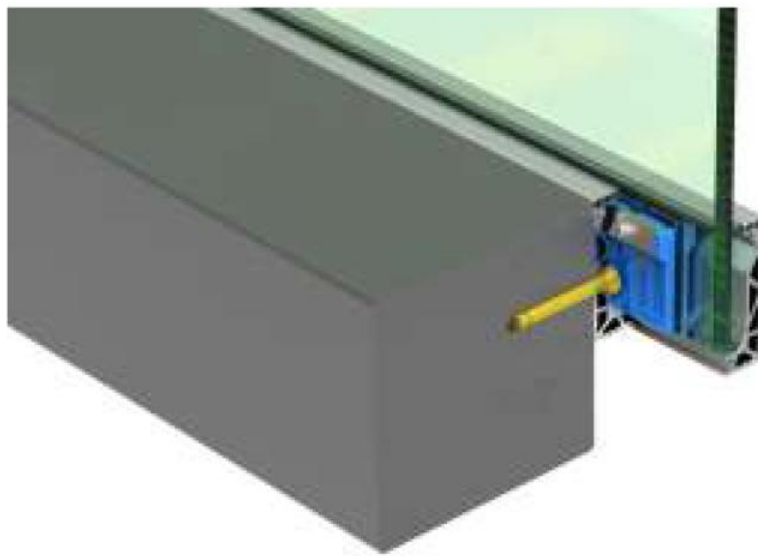

Test Method

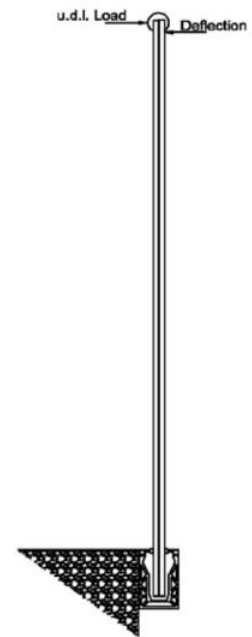

Fixing and

Glass Type	Horizontal U.D.L. kN/m	Height mm	Deflection mm
15mm Toughened, Heat Soaked	0.36	1100	11.65
15mm Toughened, Heat Soaked	0.71	1100	25.00
19mm Toughened, Heat Soaked	0.74	1093	15.38
19mm toughened, Heat Soaked	1.05	1093	25.10
21.5mm EVA Laminated Toughened Heat Soaked	0.36	1085	8.37
21.5mm EVA Laminated Toughened, Heat Soaked	0.74	1085	18.65
21.5mm EVA Laminated Toughened, Heat Soaked	0.95	1085	25.00
21.5mm Rigid Laminated Toughened, Heat Soaked	0.74	1100	13.20
21.5mm Rigid Laminated Toughened, Heat Soaked	1.00	1100	19.43
21.5mm Rigid Laminated Toughened, Heat Soaked	1.15	1100	25.00

Side Fixed Onto Steel

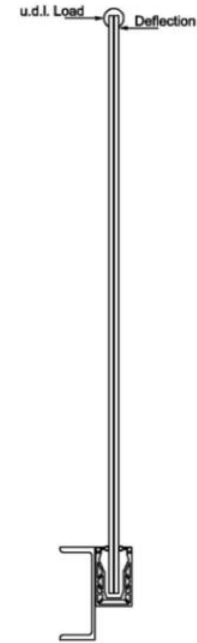

Fixing and Test Method

Glass Type	Horizontal U.D.L. kN/M	Height mm	Deflection mm
15mm Toughened Heat Soaked	0.36	1113	10.35
15mm Toughened Heat Soaked	0.74	1113	24.50
19mm Toughened Heat Soaked	0.74	1101	17.60
19mm Toughened Heat Soaked	0.91	1101	25.00
21.5mm EVA Laminated Toughened Heat Soaked	0.36	1090	8.09
21.5mm EVA Laminated Toughened Heat Soaked	0.74	1090	18.85
21.5mm EVA Laminated Toughened Heat Soaked	0.89	1090	25.00
21.5mm Rigid Laminated Toughened Heat Soaked	0.36	1112	6.31
21.5mm Rigid Laminated Toughened Heat Soaked	0.74	1112	13.13
21.5mm Rigid Laminated Toughened Heat Soaked	1.00	1112	20.50
21.5mm Rigid Laminated Toughened Heat Soaked	1.08	1112	25.00

Red writing indicates maximum loading up to the 25mm maximum deflection as per BS 6180:2011

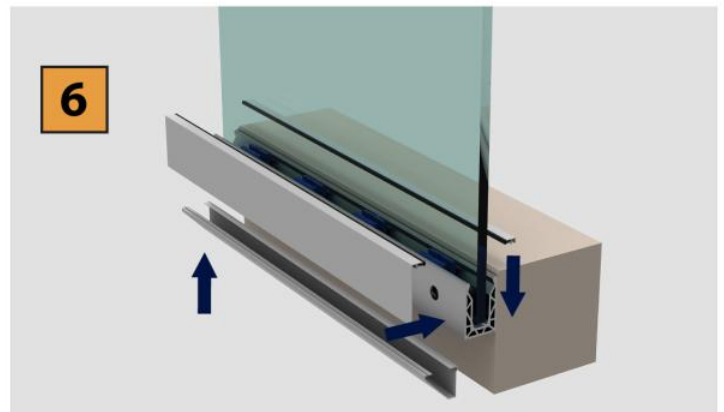
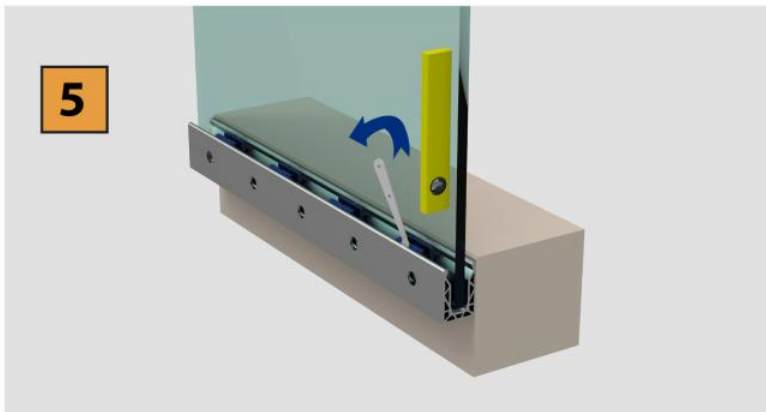
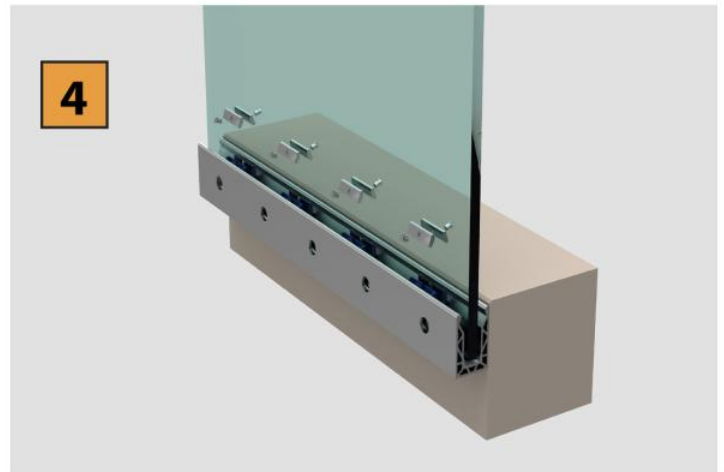
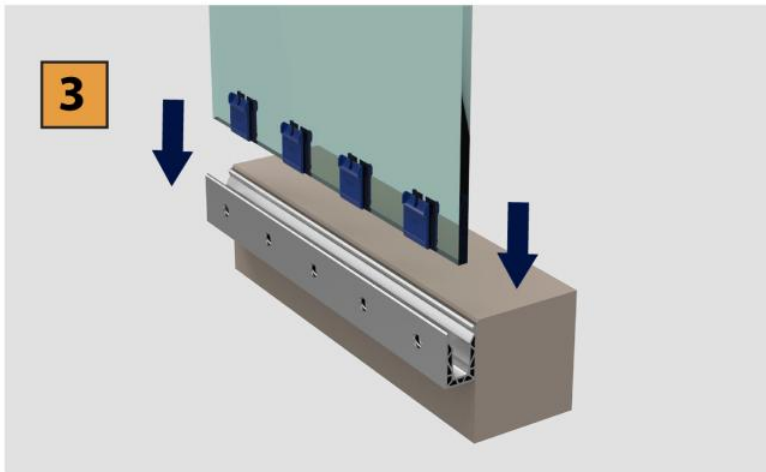
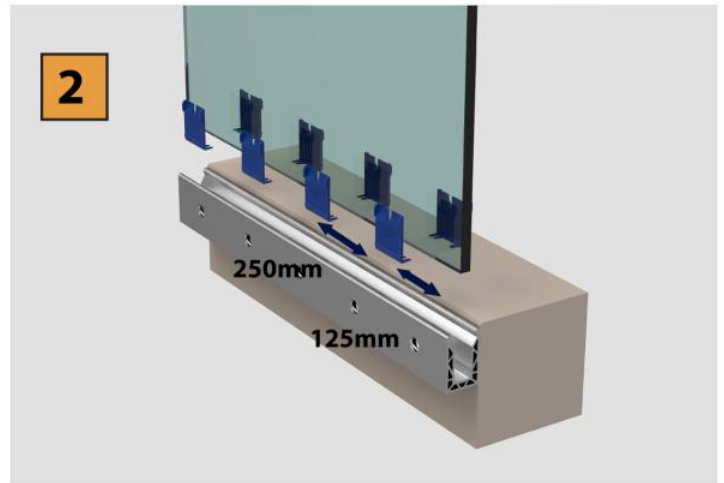
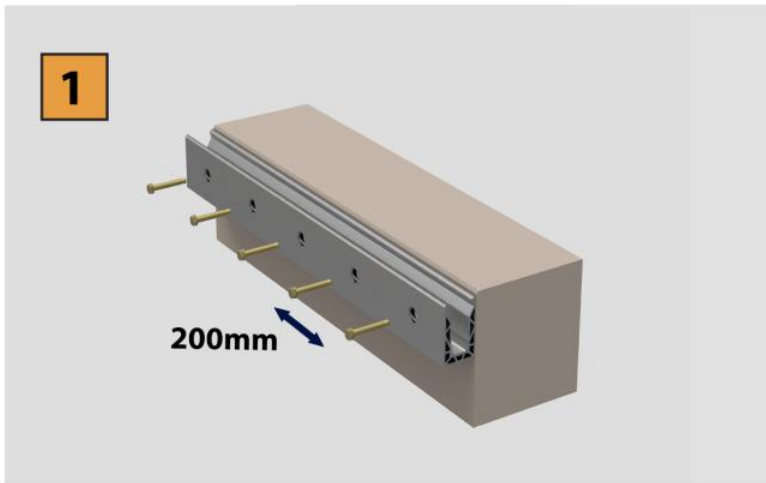
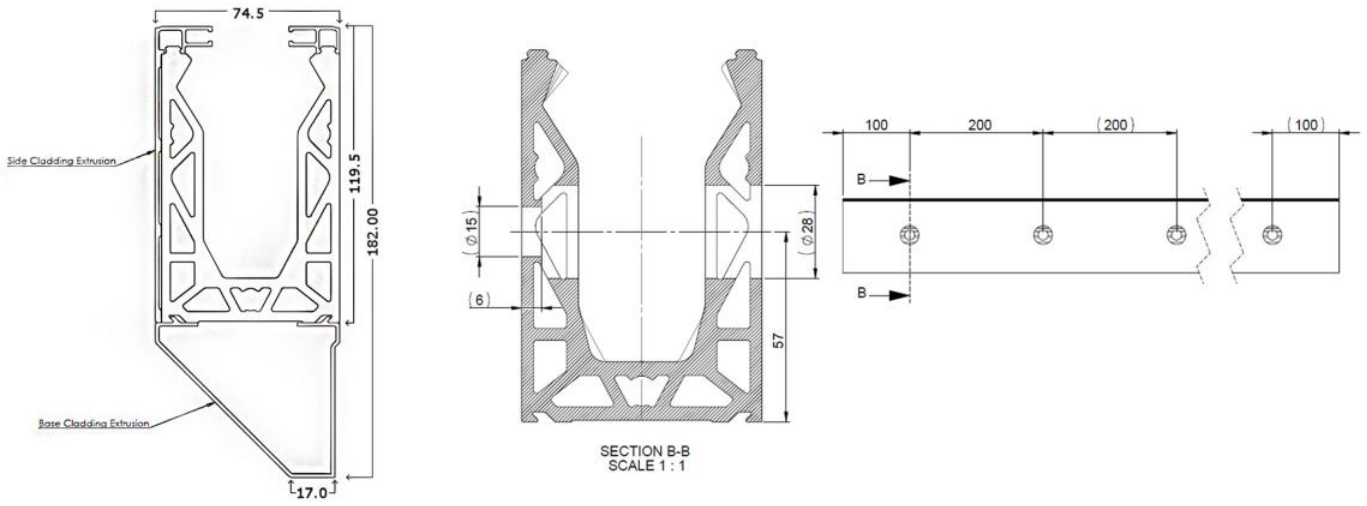

Fitting Instructions

1. The aluminium base rail should be put into place with the holes marked onto the substrate for drilling, and the aluminium base rail should then be levelled and plumbed up with the use of shims. Once the shoe is plumb and level, the fixings should be tightened up to make the channel rigid. The fixings should be tightened in accordance with the manufactures.

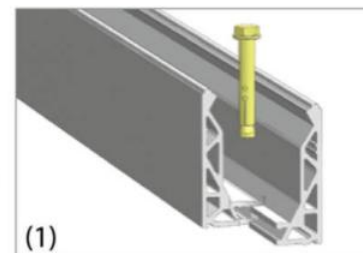

2. The glass slip clamp needs to be placed on the bottom of the glass. This requires lifting the glass off the floor sufficiently to squeeze these on or turning the glass upside down. The slip clamps require spacing according to the glass thickness these are as followed:-

- All glass types require 4 clamps per metre so number one should be in 125mm from the end of the glass and then 250mm thereafter.

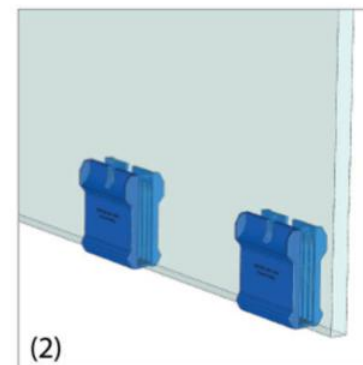

3. Once the glass is fitted into place, you now need to press the clamp bars into the top of each glass slip clamp. These need to be put in the right way for correct and proper fitment – this is shown in the image on the right.

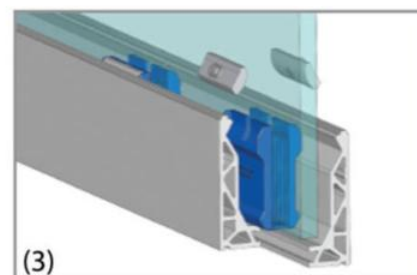

4. Once these are in you now need to place a spirit level on the glass to get the glass plumb. These bolts now need tightening into the channel equally to keep the same pressures on the glass. To achieve this initially make sure they are plumb and level at each end of the glass and tighten. Then tighten the intermediate clamp bars. Once the bolts have pinched they now require an additional quarter to lock the glass in place.

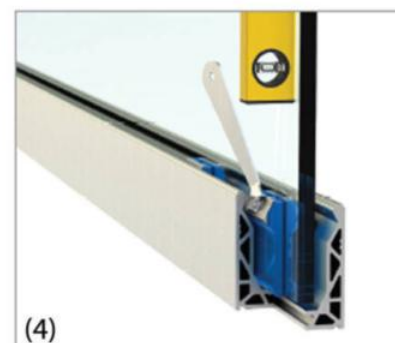

5. The gasket requires feeding into smaller channels supplied. Once these are flush with each end the strip now needs to be clipped onto the top channel. This can be done by either pressing the whole thing on evenly or working from one end which is recommended. Do not stretch the gasket.

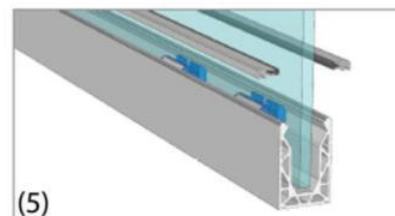

6. Once you are happy everything is in place and the job is complete you need to clean the glass and the channel. We recommend the use of any standard glass cleaner so long as it is not abrasive. We also recommend a soft sponge or cloth again to avoid any risk of scratching.

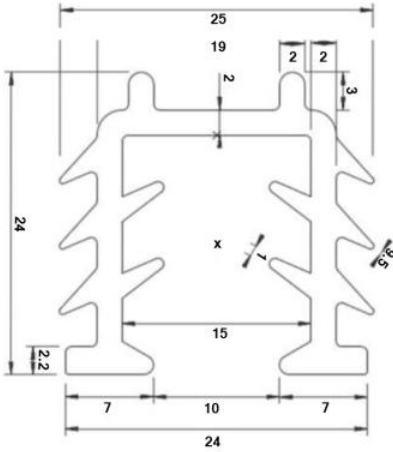
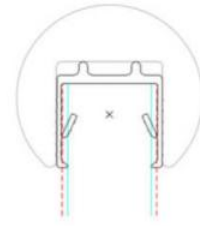
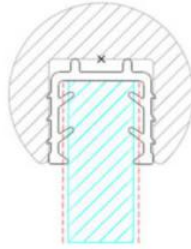
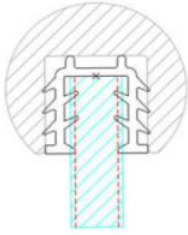

RO42-12
For 10-12.75mm Glass

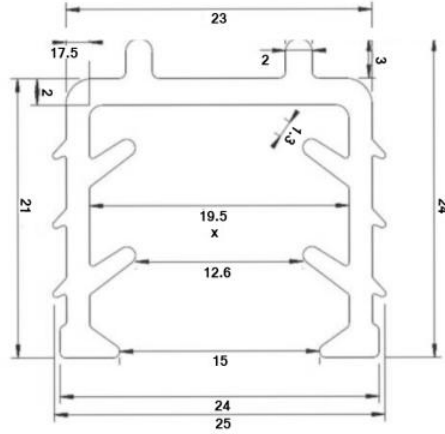

RO42-15NEW
For 15-17.5mm Glass

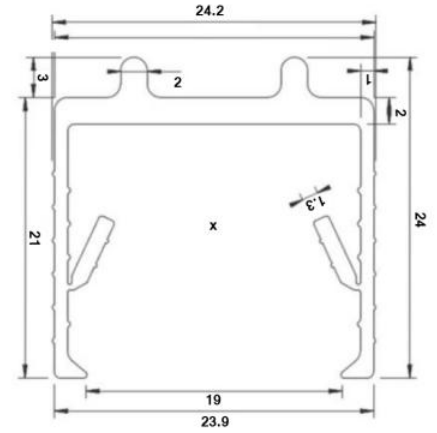

RO42-19
For 19-21.5mm Glass

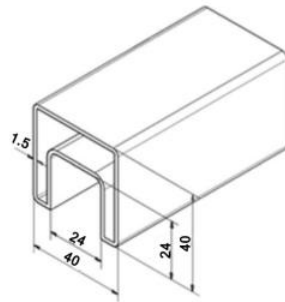

RO1004-BOXx40x40
40 x 40mm Profile Box Section

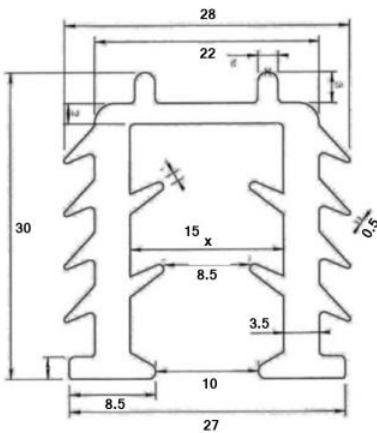

RO48-12
For 10-12 mm Glass

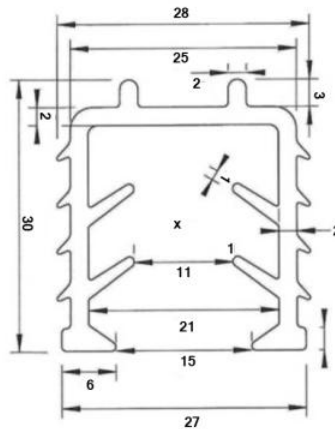

RO48-15
For 15-17.5 mm Glass

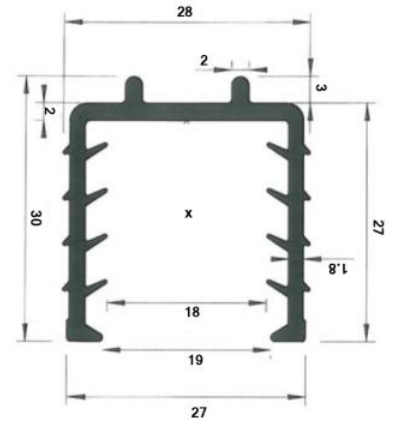

RO48-19
For 19- 21.5 mm Glass

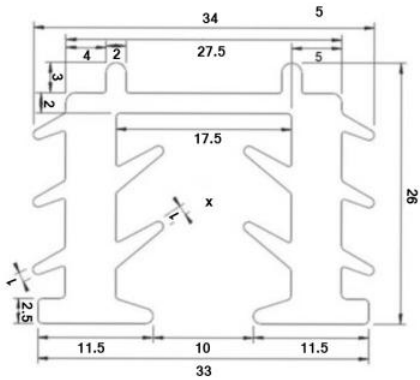

RO80/110-12
For 10-12.75mm Glass

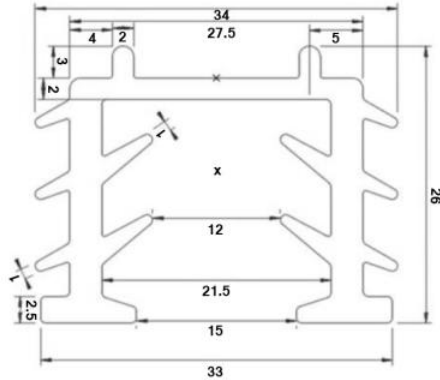

RO80/110-15
For 15-17.5mm Glass

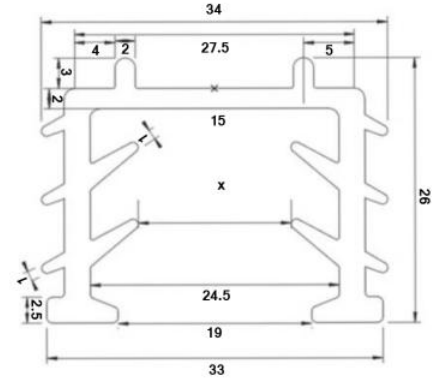

RO80/110-19
For 19-21.5mm Glass

Capping Rails

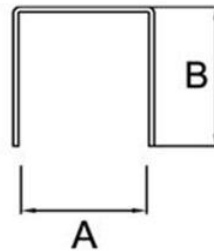

2.5m Length A: 12-12.76mm B: 15mm 1.5mm Wall
 2.5m Length A: 16.76-17.52mm B: 20mm 1.5mm Wall
 2.5m Length A: 19-21.52mm B: 20mm 1.5mm Wall
 ••Satin anodised capping rail
 Many other sizes available on request

KT-Capping-Rail
Satin anodised aluminium capping rails for 12-21.5mm glass



Double Sided Tape
10-12.76mm Glass
KT-PR-7426

Double Sided Tape
15-17.52mm Glass
KT-PR-6728

Double Sided Tape
19-21.52mm Glass
KT-PR-6936

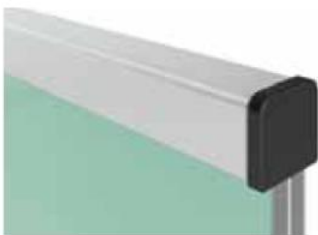

KT-PR-6540
W:27.7mm / H: 25.1mm
Wall: 1.6mm

KT-AK-6540TA

KT-AK-6540F
Radius: 25mm
Slot: 27.7mm

KT-AK-6540V

KT-AK-6540H

KT-AK-6540KD

KT-AK-6540KD1

KT-AK-6540T

KT-AK-6540C

KT-AK-6728F



RO1001 - Round Tube
 33.7 x 2MM, 42.4 x 2MM, 42.4 x 2.5MM,
 48.3 x 2MM, 48.3 x 2.6MM, 50.8 x 1.5MM
 50.8 x 3MM, 60.3 x 4MM
 304 Satin / 316 Satin / 316 Mirror



ST1001 / WT14 - Rod
 10mm, 12mm, 14mm
 304 Satin / 316 Satin



RO1001-Box - 40 x 40 Square Tube
 304 Satin / 316 Satin



RO1004-Box - Square / Rectangle Slotted Tube
 40 x 40 - 304 Satin / 316 Satin
 60 x 40 - 304 Satin / 316 Satin



RO1002 / RO1004 - Round Slotted Tube
 42.4 - 304 Satin / 316 Satin / 316 Mirror
 48.3 - 304 Satin / 316 Satin / 316 Mirror
 60.3 - 316 Satin



RO1004-Oval - Oval Slotted Tube
 80 x 40 - 304 Satin / 316 Satin
 110 x 40 - 304 Satin / 316 Satin



1201.425.304/316
Slotted Tube Connector
304/316

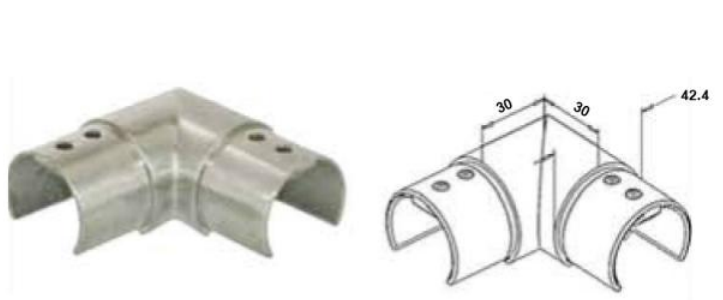

1202.425.304/316
90 Degree Slotted Lateral Bend
304/316



1203.425.304/316
90 Degree Slotted Vertical Bend
304/316

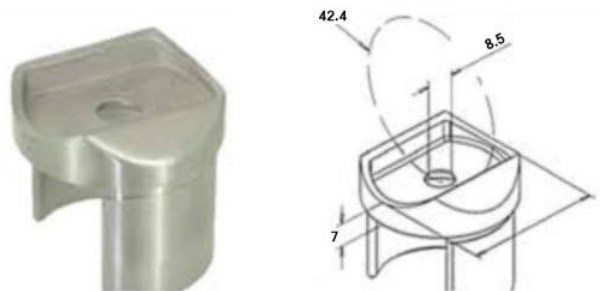

1502.424.304/316
Slotted Adaptor
304/316

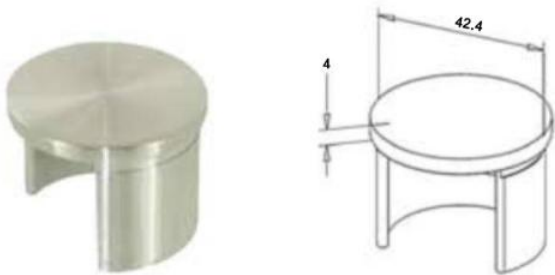

1112.426.304/316
Slotted End Caps
304/316

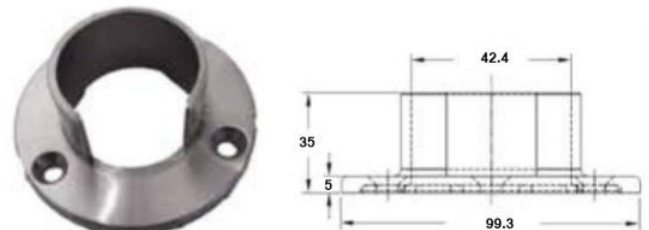

RO1009-42.4
Slotted Wall Plate
304/316

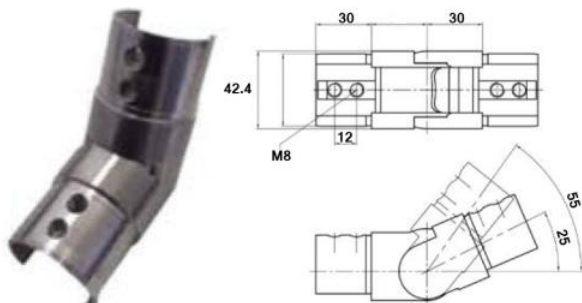

RO1012-42.4
25-55 Degree Slotted Elbow (Upwards)
316

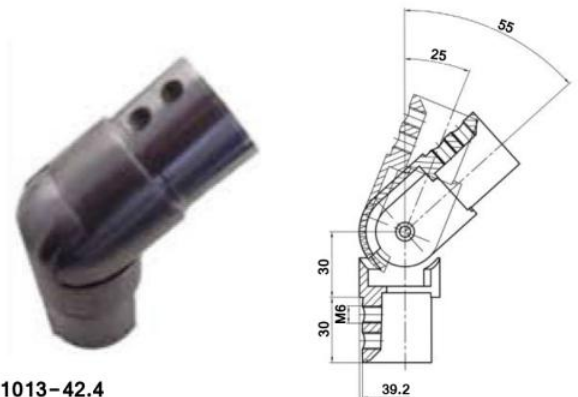

RO1013-42.4
25-55 Degree Slotted Elbow (Downwards)
316



1201.485.304/316
Slotted Tube Connector
304/316

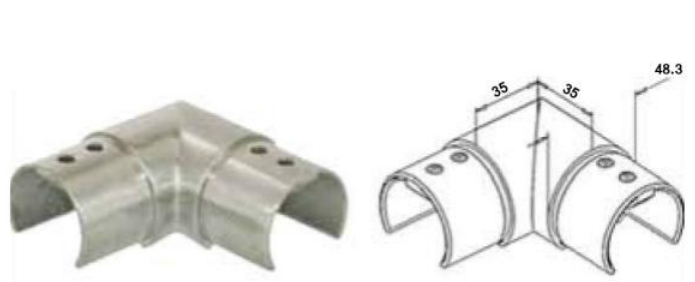

1202.485.304/316
90 Degree Slotted Lateral Bend
304/316



1203.485.304/316
90 Degree Slotted Vertical Bend
304/316

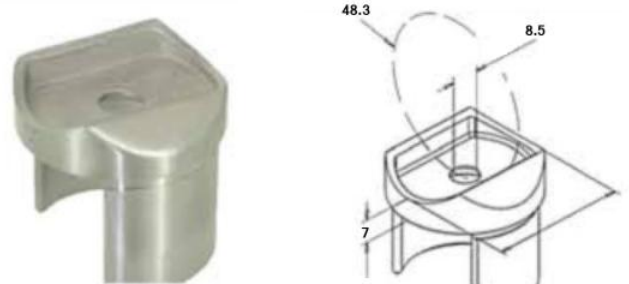

1503.483.304/316
Slotted Adaptor
304/316

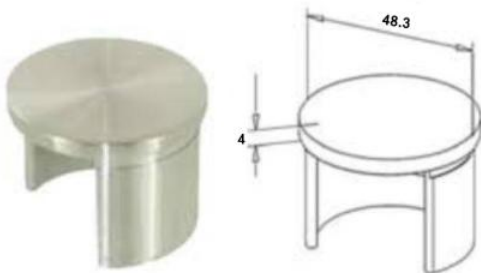

1112.486.304/316
Slotted End Caps
304/316

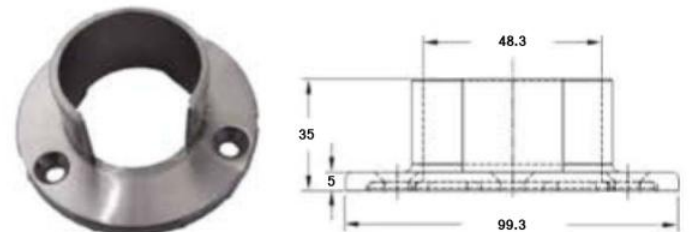

RO1009-48.3
Slotted Wall Plate
304/316

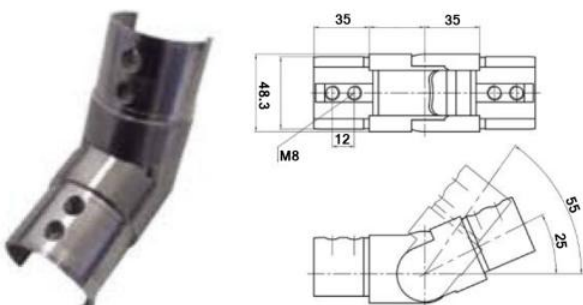

RO1012-42.4
25-55 Degree Slotted Elbow (Upwards)
316

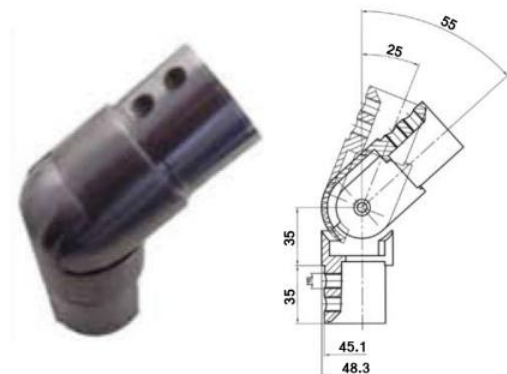

RO1013-42.4
25-55 Degree Slotted Elbow (Downwards)
316

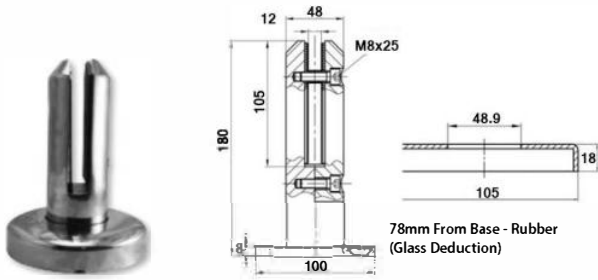

GLH1080
Round Spigot & Base (Rubbers for 10 and 12mm)
316G Satin and Mirror

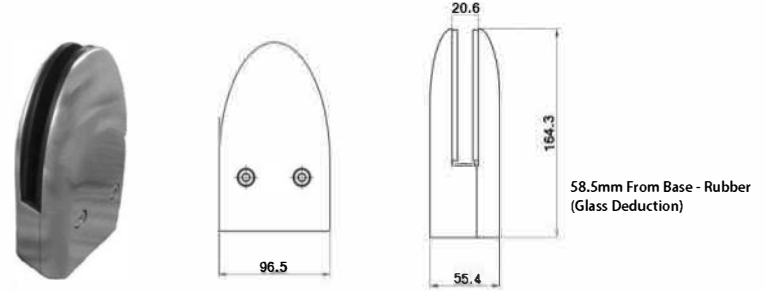

GLH1081
Novo Spigot (12mm Glass)
316G Satin

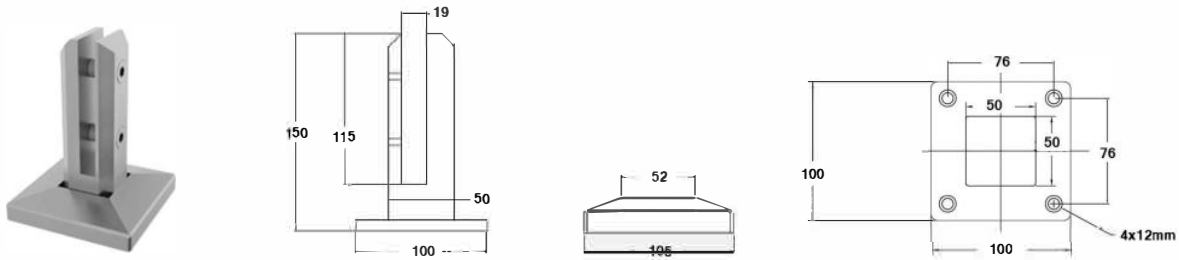

GLH1090
Square Spigot & Base (Rubbers for 10 and 12mm)
316G Mirror

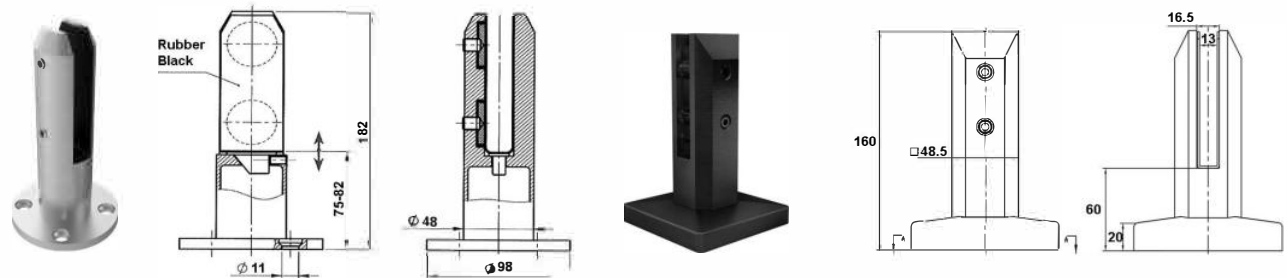

GLH1082
Round Spigot (Cover Available) 316G Satin
To Suit 12-17.52mm Glass

KT-Spigot-Black
PVD Coated Black Spigot
To Suit 10-12mm Glass



KT-Tilt-Lock
Duplex Stainless Steel 2205
Satin Finish
12-25.52mm Glass

KT-Spigot-Tilt
Duplex Stainless Steel 2205
Satin Finish
12-25.52mm Glass

20, 30, 40, & 50mm Spacers Now Available for JK-1014 & JK-1017 Satin & Mirror Finish

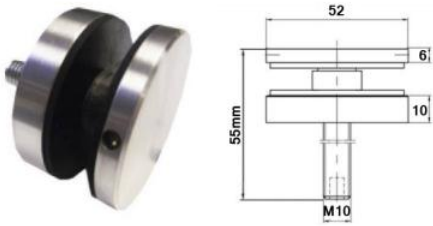

JK-1014
Solid Threaded Body – Flat Head
M10 Removable Thread
304/316

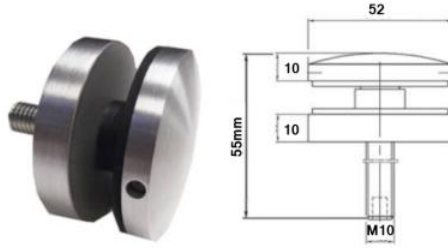

JK-1017
Solid Threaded Body – Convex Head
M10 Removable Thread
304/316

*150mm Long M10 Threaded Bar Also Available Upon Request

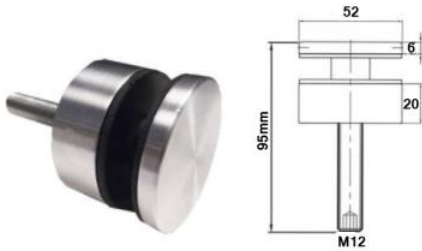

JK-1015
Solid Threaded Body – Flat Head
M12 Removable Thread
304/316

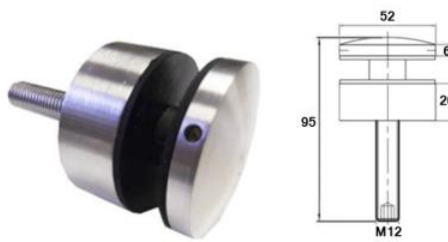

JK-1018
Solid Threaded Body – Convex Head
M12 Removable Thread
304/316

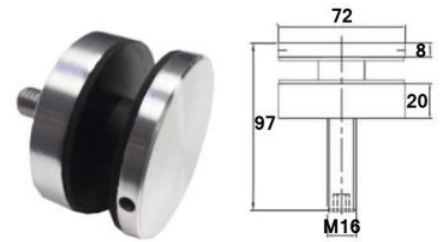

JK-1016
Solid Threaded Body – Flat Head
M16 Removable Thread
304/316

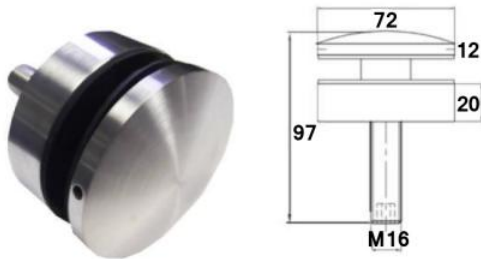

JK-1019
Solid Threaded Body – Convex Head
M16 Removable Thread
304/316

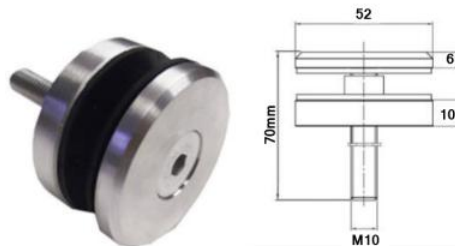

JK-1012
Solid Threaded Body – Screw Head
M10 Removable Thread
304/316



JK-1013
Solid Threaded Body – Screw Head
M12 Removable Thread
304/316

Spanners Available:

- JK-Spanner-52
- JK-Spanner-72
- JK-Spanner-Adjustable (30-72mm)
- JK-Flexible-Spanner (52mm Wide)



JK-Flexible-Spanner:



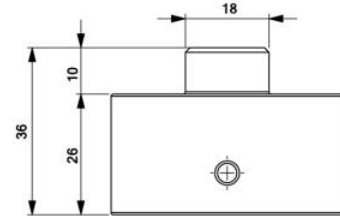
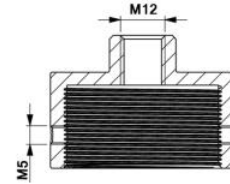
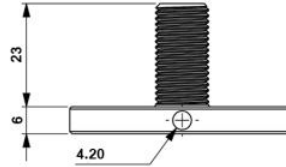
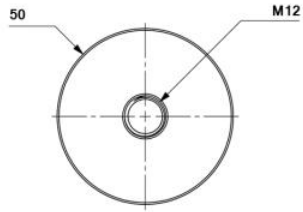

KT-ADJ-STAND-30
Adjustable Stand-Off, Satin or Mirror
W 50mm x L 30mm 10-21.52mm Glass
Duplex 2205

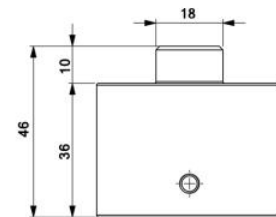
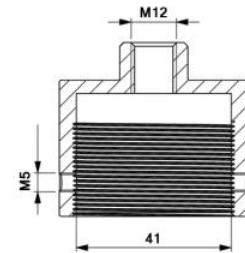
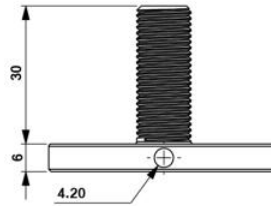
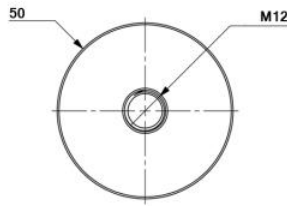

KT-ADJ-STAND-40
Adjustable Stand-Off, Satin or Mirror
W 50mm x L 40mm 10-21.52mm Glass
Duplex 2205

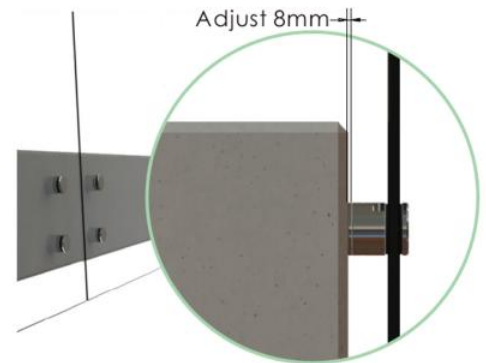
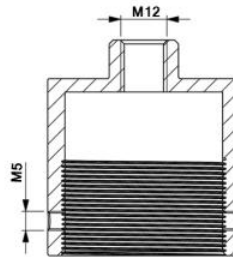
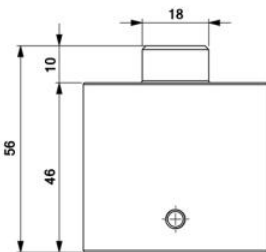

KT-ADJ-STAND-50
Adjustable Stand-Off, Satin or Mirror
W 50mm x L 50mm 10-21.52mm Glass
Duplex 2205

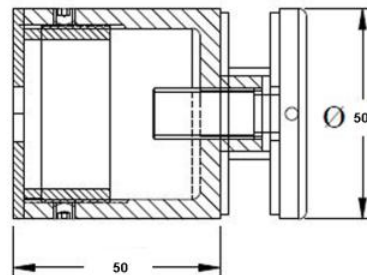

KT-ADJ-STAND-BLACK-50
Adjustable Stand-off
Black Finish
W 50mm x L 50mm 10-21.52mm Glass

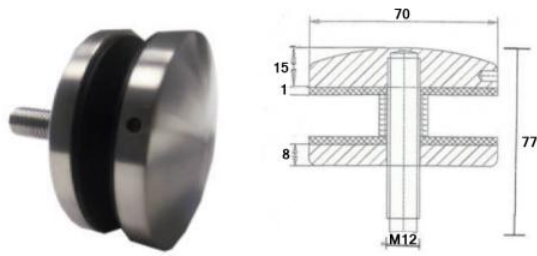

GLH1070-M12
70mm Face - M12 Removable Thread
316

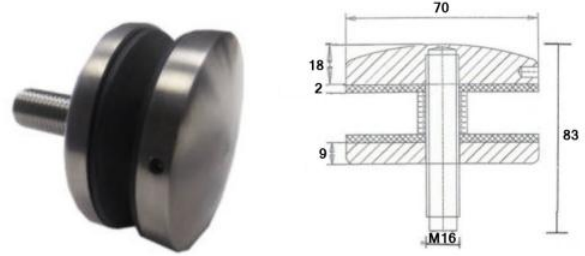

GLH1070-M16
70mm Face - M16 Removable Thread
316

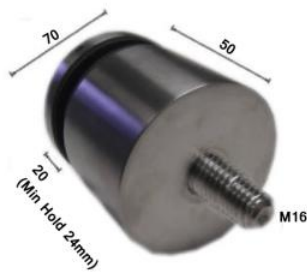

GLH1070-M16 - Glass Retainer 304/316
GLH1070-M16-EXT316 - Glass Retainer 304/316

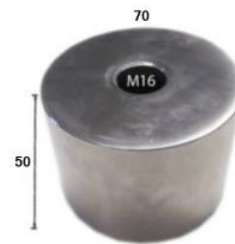

GLH1070-M16-EXT316
50 x 70 x M16
(Spacer Only)
304/316



••Brand New••
Stand-Offs for Signs
19mm and 25mm Width
25mm and 40mm Off-Set

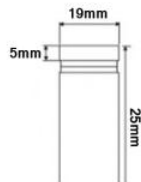

KT-Sign-19x25mm
304G, Satin

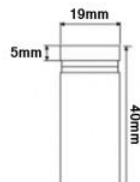

KT-Sign-19x40mm
304G, Satin

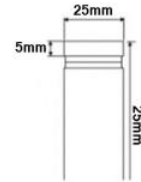

KT-Sign-25x25mm
304G, Satin

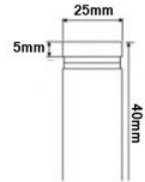

KT-Sign-25x40mm
304G, Satin

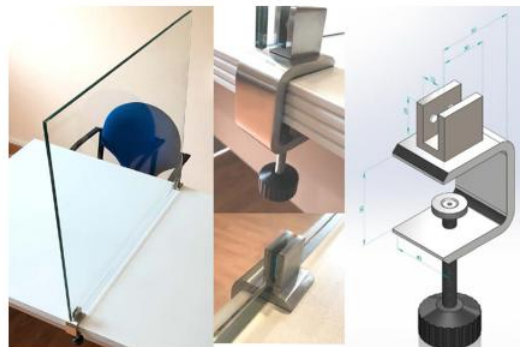
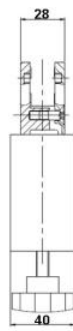
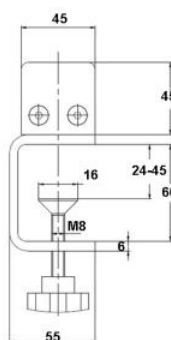

KT-Sneeze-Screen-Clamp
304 Grade To Suit 6 / 8 / 10mm Glass

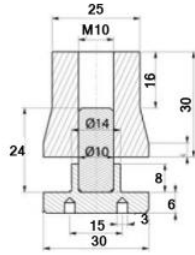

GLH1013K-30
Solid Threaded Body - Pig Nose
M10 Removable Thread
316

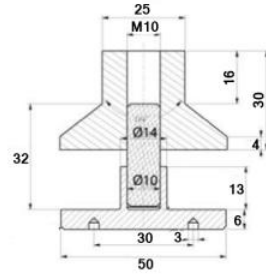
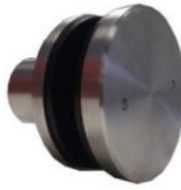

GLH1013K-50
Solid Threaded Body - Pig Nose
M10 Removable Thread
304/316

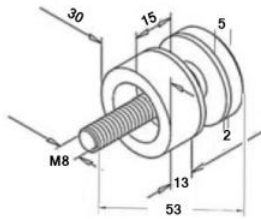

GLH1014K
Flat Face Glass Retainer
316

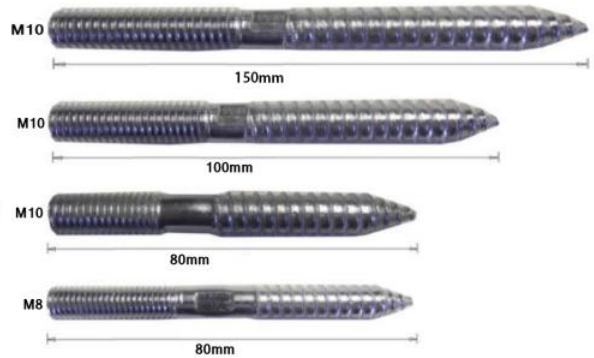

M10-Dowel-150mm
M10-Dowel100
M10-Dowel80
M8-80-Dowel

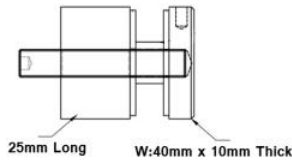

GLH1017-A-Satin
GLH1017-A-Mirror
W:40mm x L:25mm

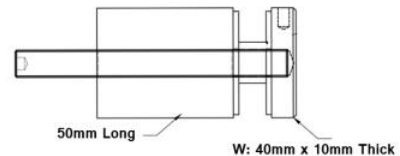

GLH1017-B-Satin
GLH1017-B-Mirror
W:40mm x L:50mm

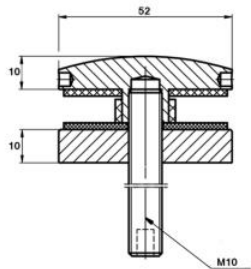

JK-1017-Black
316 Grade - Black Finish
Stand Offs

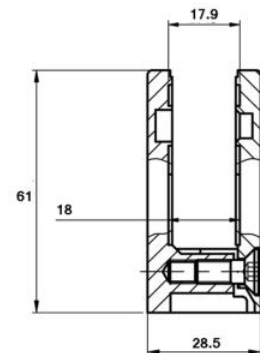

KLH10F-Black
316 Grade - Black Finish
Flat Back Glass Clamp - 10mm Rubbers Included

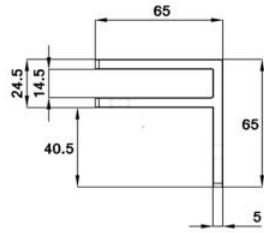

KLH10-STIFF-WALL
Duplex Stainless - Satin Finish
10-12mm Wall to Glass Stiffener

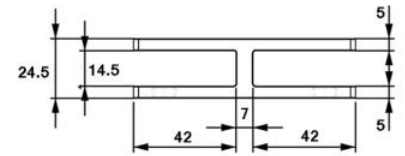

KLH10-STIFF-180
Duplex Stainless Steel - Satin Finish
10-12mm 180 Degree Glass Stiffener

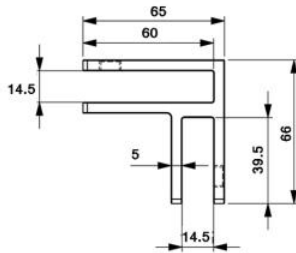

KLH10-STIFF-90
Duplex Stainless - Satin Finish
10-12mm 90 Degree Glass Stiffener

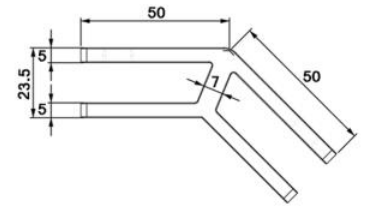

KLH10-STIFF-135
Duplex Stainless - Satin Finish
10-12mm 135 Degree Glass Stiffener

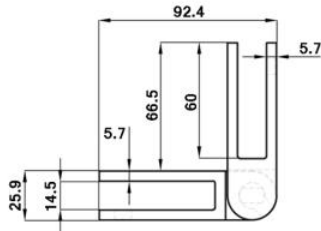

KLH10-STIFF-ADJ
Duplex Stainless - Satin Finish
10-12mm Adjustable Glass Stiffener

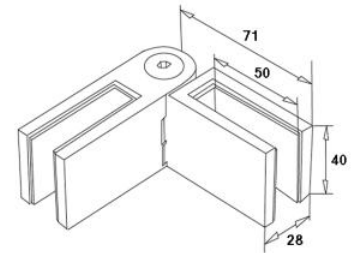

KLH10-Adjustable
316 Grade - Satin Finish - 10-12mm Glass
Adjustable Glass Clamp

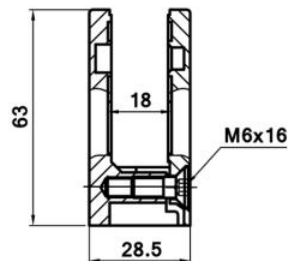

KLH13.52-15MM-FLAT-SATIN
316 Grade Satin Finish
Suitable for 13.52 and 15mm Glass

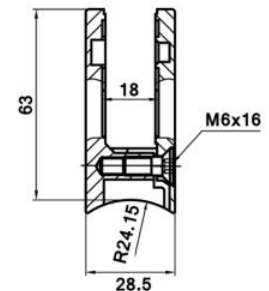

KLH13.52-15MM-48.3-SATIN
316 Grade Satin Finish
Suitable for 13.52 and 15mm Glass

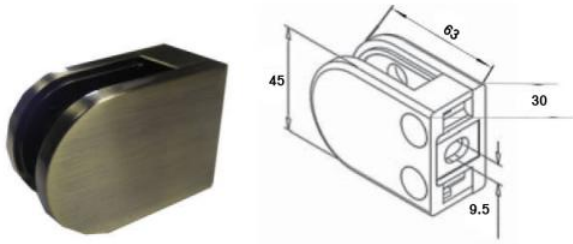

KLH10F-ANT-BRASS
Powder Coated, Antique Brass Glass Clamp
10mm Glass. 6/8/12mm Rubbers Also Available

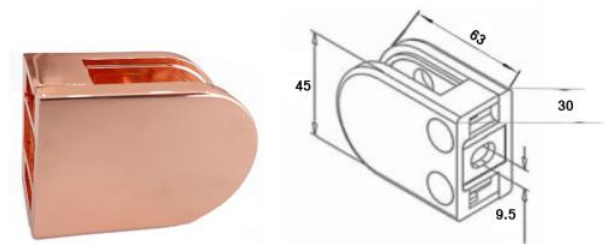

KLH10F-ROSE-GOLD
Rose Gold Glass Clamp
10mm Glass. 6/8/12mm Rubbers Also Available

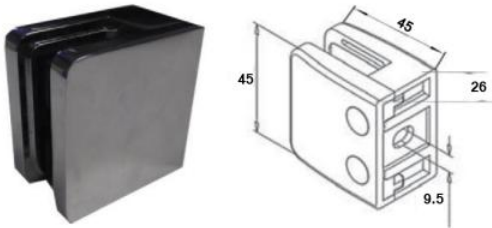

KLH10F-45/45
Satin Finish - 10mm Glass (No Pin)
304

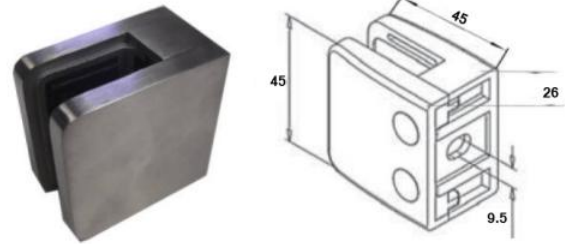

KLH10F-45/45-Zintec
St/St Effect - 10mm Glass
Zamack Glass Clamp (No Pin)

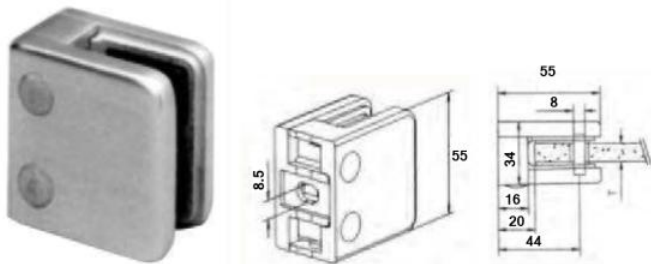

KLH12F
304/316G Satin/Mirror
Flat - Square 55 x 55mm
304/316

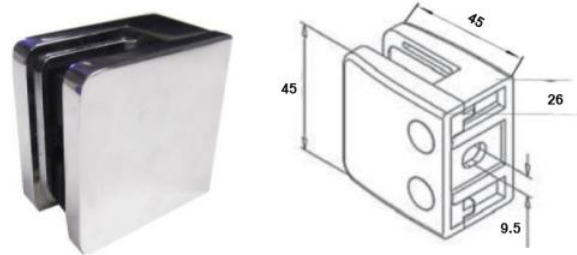

KLH10F-45/45-M
Zamack Mirror Finish - 10mm Glass (No Pin)

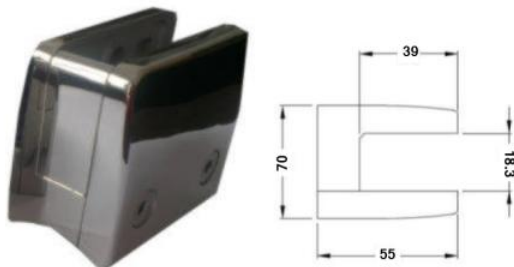

KLH13.52-17.52FLAT
KLH13.52-17.52R50.8
13.52 - 16.76 - 17.52mm Rubbers (Sold Separately)
316G Mirror

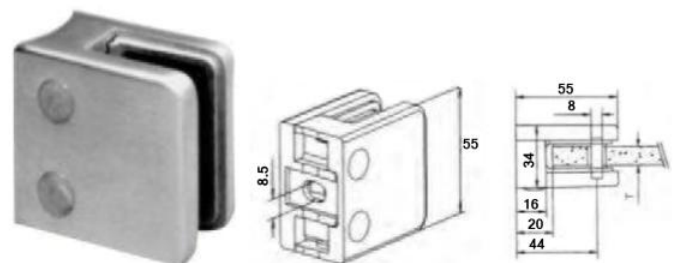

KLH12R-42MM
304G Satin
Round - 12mm - Square 55 x 55mm
304

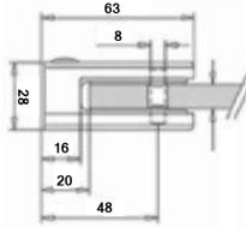
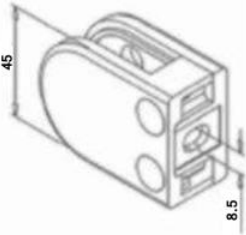

KLH10F-K-304 - 304 Grade, Satin 6-12mm Glass
 KLH10F-K - 316 Grade, Satin 6-12mm Glass
 KLH10F/M - 304 Grade, Mirror 6-12mm Glass
 KLH10F-K-316Mirror - 316 Grade, Mirror 6-12mm Glass
 KLH10U-FK - Untreated 6-12mm Glass
 KLH10Z-F-K - Zintec (Indoor) 6-12mm Glass
 All clamps with 10mm rubbers included. 6,8 and 12mm rubbers sold separately



10mm Rubber

GLH1016-10mm-Rubber



12mm Rubber

GLH1016-12mm-Rubber



13.52mm



16.76mm



17.52mm

Rubbers for 70 x 50mm Clamps

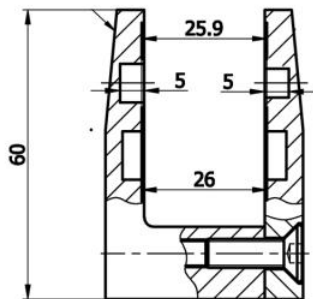
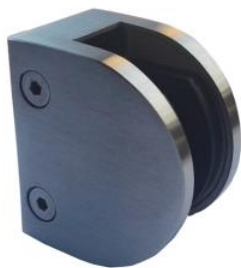

KLH21.5MM-F-316
 Suitable For 15, 17.52, 19 and 21.52mm Glass
 316 Grade, Satin / Mirror
 60mm x 70mm

••New closed back Glass Clamp, for Welding



KLH10F-K-Closed
 Closed back glass clamp
 Suitable for 6, 8, 10 and 12mm Glass
 316 Satin

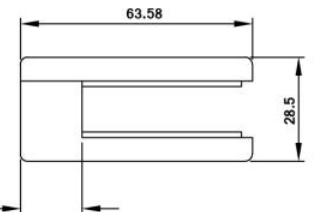
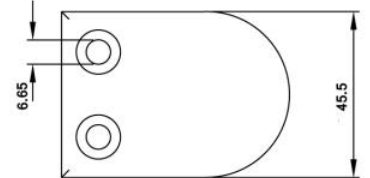

••See Dimensions Page 12



KLH21.5MM-R-316
 Suitable for 15, 17.52, 19 and 21.52mm Glass
 316 Grade, Satin / Mirror

KLH10-180D
 180 Degree Double Glass Clamp
 Rubbers for 10 and 12mm Glass
 316 Satin

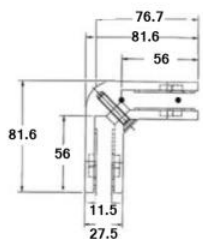

KLH10-90D
 90 Degree Double Glass Clamp
 Rubbers for 10 and 12mm Glass
 316 Satin



M8-ADJ-304/316
 M8x20mmx304/316
 M8x25mmx304/316

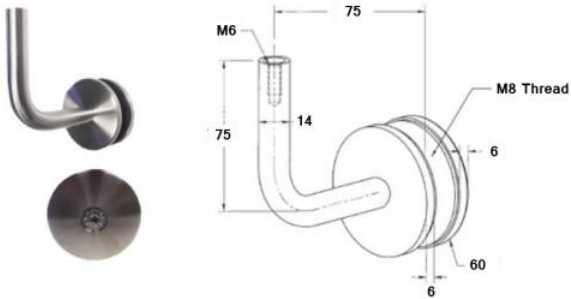

HH1013-75
Glass Bracket and Rod
304 / 316

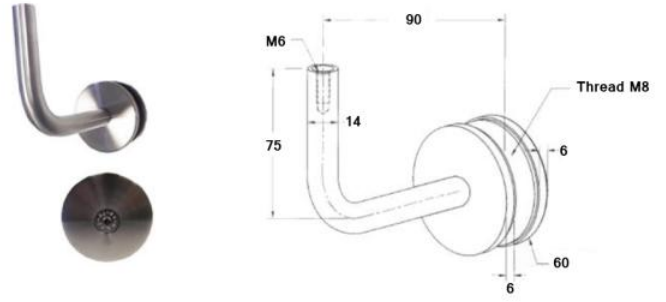

HH1013-90
Glass Bracket and Rod
304 / 316

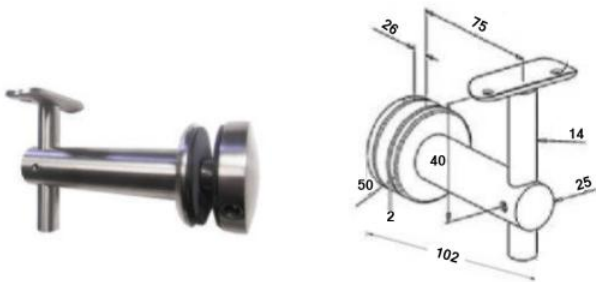

HH1015K-75
Convex Head - Glass to Handrail
304/316

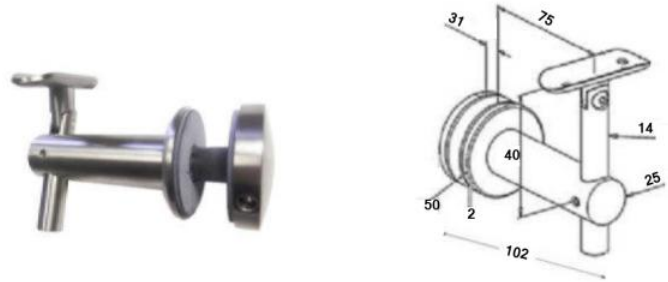

HH1015-75-ADJ
Convex Head - Glass to Handrail
304/316

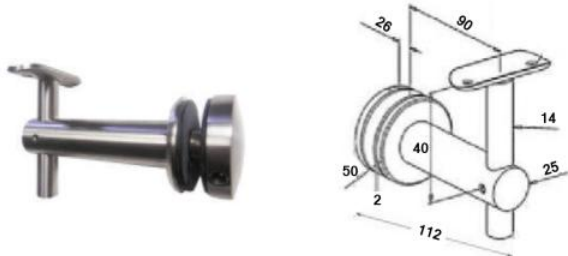

HH1015K-90mm-50.8
Convex Head - Glass to Handrail
304/316

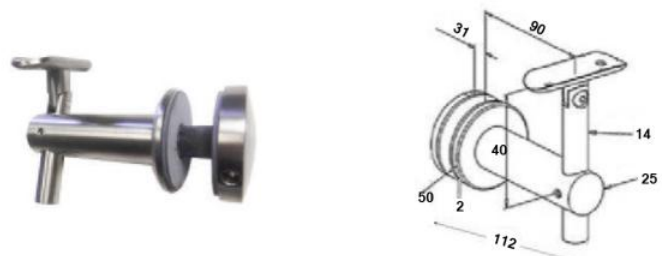

HH1015-90-ADJ
Convex Head (Adjustable) - Glass to Handrail
304/316



KLH10F-Drop-Plate + KLH10R-Drop-Plate
Flat Post / 42.4mm Post / 48.3mm Post
316 Grade Satin Finish
40 x 18mm

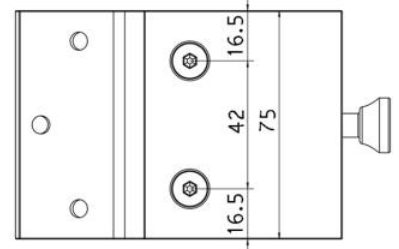
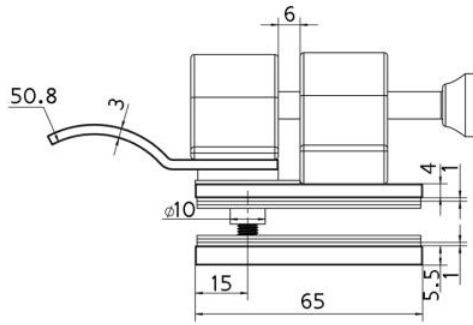

KT-Magnetic-Latch-Post
Post to Glass Magnetic Latch
316G Satin Finish - 8-12mm Glass

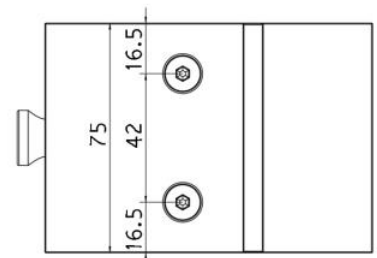
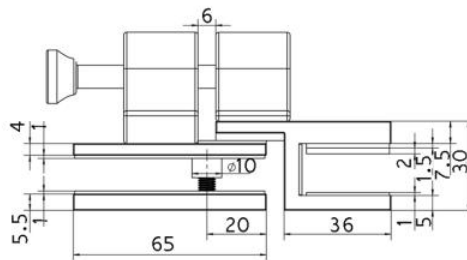

KT-Magnetic-Latch-Glass
Glass to Glass Magnetic Latch
316G Satin Finish - 8-12mm Glass

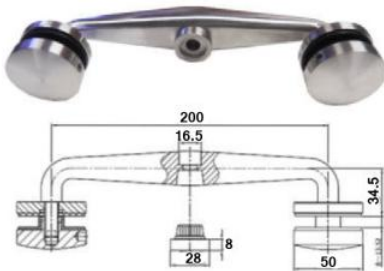

GLH1030
Glass Retainer - Flat
316



GLH1032
Glass Retainer - Flat
316

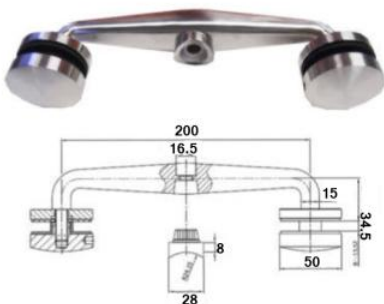
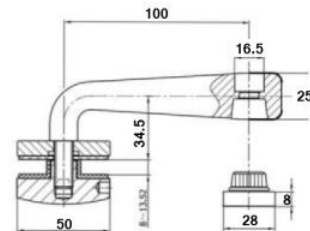

GLH1031
Glass Retainer - 48/50mm Tube
316



GLH1033
Glass Retainer - 48/50mm Tube
316

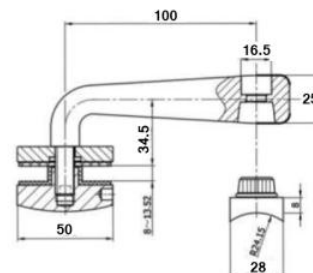



KT-Parapet-Channel

Kensington's new parapet channel is the most economic of its type, which is suitable for 8, 10 and 12mm glass and is sold in 3m lengths. The glass is fixed with glass pressing a mechanism in the main profile. It provides aesthetic and sturdy results if it is supported with on-glass profiles connected to the wall.

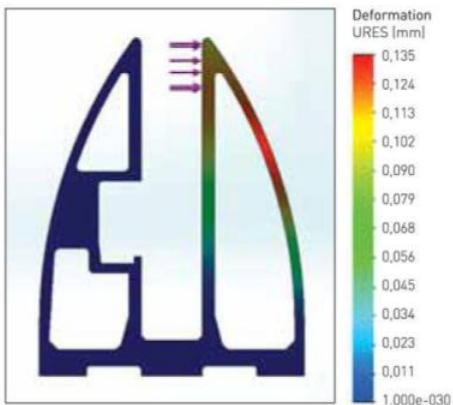

Alloy EN AW 6063
Stress and relocation results on 1 m. base profile with 350 kg horizontal load to the highest surface of the profile.

Mass : 2.77916 kg
Volume : 0.00102932 m³
Density : 2700 kg/m³
Weight : 27.2358 N

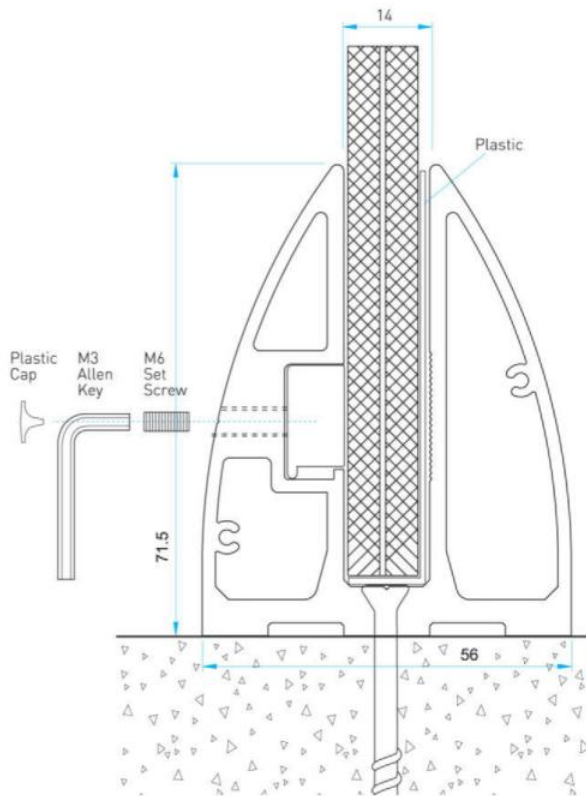

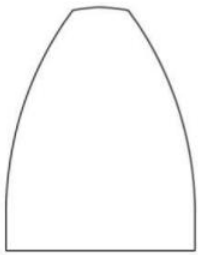

KT-Parapet-Ch-End
End Cap to suit Parapet
Channel (Ali)



KT-Glass-Aligner
Glass Aligner – 60mm Wide
10mm Plate / Ali 6063 T5

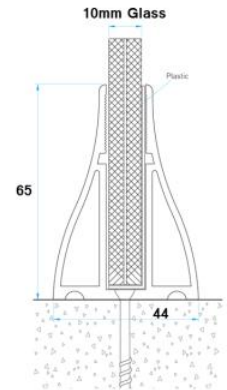

••Also available – Brand New S40E
profile, for 10mm glass

New Glass Fittings

••Available with a flat face,
or in 'Pig Nose'



••Flat Face : 35mm W x 5mm Stand-Off
and 50mm Wide x 50mm Stand-Off Available

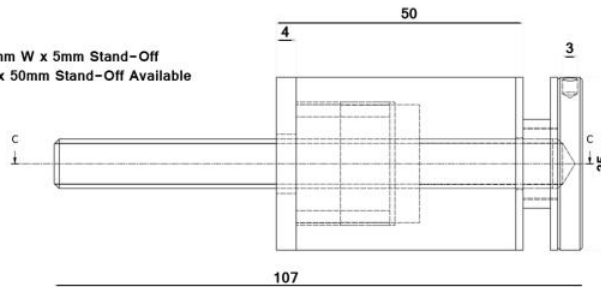

Adjustable Back Plates on All Sizes



••Pig Nose : 35mm W x 50mm Stand-Off
and 50mm Wide x 50mm Stand-Off Available

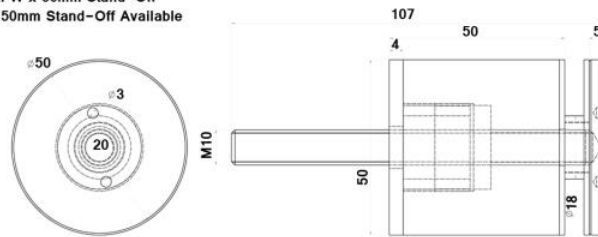

PVD Coated Stainless Steel

Available in; Black, Bronze and Brass finish / Adjustable Back Plate, 10mm Adjustment /
Pig Nose or Side Hole / 30, 40 and 50mm / Suitable for 6–17.52mm Glass / Removable Thread



JK-1030 35mm Flat Face x 50mm Offset
JK-1033 35mm Pig Nose x 50mm Offset
JK-1050 50mm Flat Face x 50mm Offset
JK-1053 50mm Pig Nose x 50mm Offset



JK-1031 35mm Flat Face x 50mm Offset
JK-1051 50mm Flat Face x 50mm Offset
JK-1054 50mm Pig Nose x 50mm Offset



JK-1035 35mm Pig Nose x 50mm Offset
JK-1052 50mm Flat Face x 50mm Offset
JK-1055 50mm Pig Nose x 50mm Offset



KT-Juliet-Set
 316 Grade Satin Finish
 Juliet Balcony Set (Not Including Glass)
 Includes 4 x Brackets Suitable for 42.4mm Slotted Tube

Slotted Tube
 RO1002
 42.4 x 1.5mm Wall
 304 or 316 Grade Satin
 3 or 6 Metre Lengths

KT-Juliet-Bracket
 316 Grade Satin Finish
 Mid-Bracket for Juliet Set

*Suitable for 12 - 17.52mm Glass

**Installation instructions available upon request



GLH1010K-30-42.4
Double Glass Retainer
304



GLH1011K
Single Glass Retainer
304



GLH1010K-30-50.8
Double Glass Retainer
316



GLH1011K-30-50.8
Single Glass Retainer
316

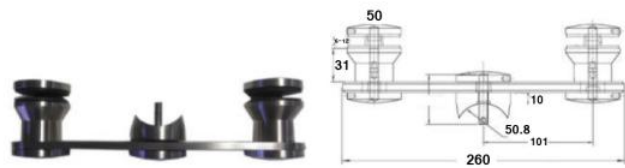

GLH1010K-50-50.8
Double Glass Retainer (50 x 50mm)
316



GLH1011K-50.8
Single Glass Retainer (50 x 50mm)
316



Reverse View of the Double Glass Retainer



Reverse View of the Single Glass Retainer



KT-Hinge-Glass-Glass
Glass to Glass Hinge
316G, Satin

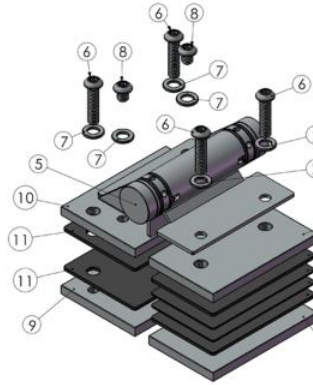

- Part 1 – Front Plate 48 x 78 Quantity : 1
- Part 2 – Back Plate 48 x 78 Quantity : 1
- Part 3 – Plastic 48 x 78 x 1 Quantity : 2
- Part 4 – Plastic 48 x 78 x 2 Quantity : 2
- Part 5 – Hinge – Quantity : 1
- Part 6 – Screw M6 x 28 Quantity: 4
- Part 7 – M6 Gasket Quantity : 6
- Part 8 – Screw M6 x 10.5 Quantity : 2
- Part 9 – Back Plate 55 x 78 Quantity : 1
- Part 10 – Front Plate 55 x 78 Quantity : 1
- Part 11 – Plastic 55 x 78 x 2 Quantity : 2
- Note: Form into a single hinge fitting, a pair must x 2



KT-Hinge-Post-Glass
Glass to Post Hinge 48.3mr
316G, Satin

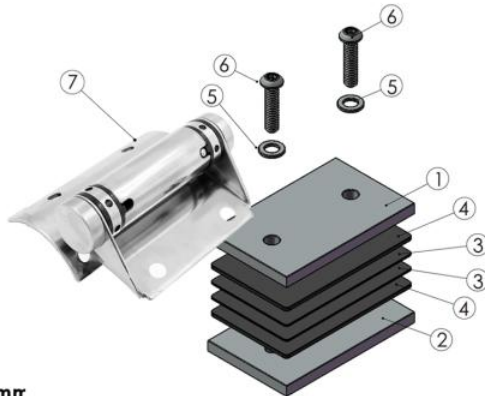

- Part 1 – Front Plate 48 x 78 Quantity : 1
- Part 2 – Back Plate 48 x 78 Quantity : 1
- Part 3 – Plastic 48 x 78 x 1 Quantity : 2
- Part 4 – Plastic 48 x 78 x 2 Quantity : 2
- Part 5 – M6 Gasket Quantity : 4
- Part 6 – M6 x 28 Screw Quantity : 4
- Part 7 – Main Body Quantity : 1
- Note: Form into a single hinge fitting, a pair must be x 2



KT-Hinge-Flat-Glass
Glass to Square Post Hinge
316G-Satin

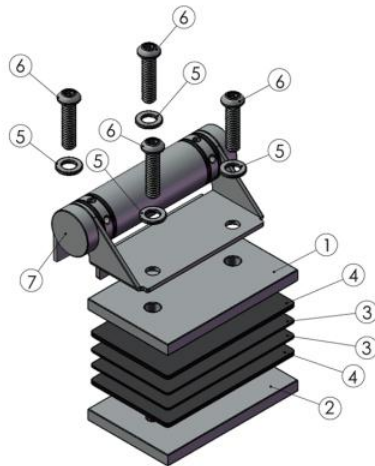

- Part 1 – Front Plate 48 x 78 Quantity : 1
- Part 2 – Back Plate 48 x 78 Quantity : 1
- Part 3 – Plastic 48 x 78 x 1 Quantity : 2
- Part 4 – Plastic 48 x 78 x 2 Quantity : 2
- Part 5 – M6 Gasket Quantity : 4
- Part 6 – M6 x 28 Screw Quantity : 4
- Part 7 – Main Body Quantity : 1
- Note: Form into a single hinge fitting, a pair must be x 2

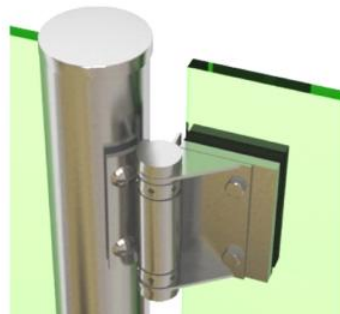
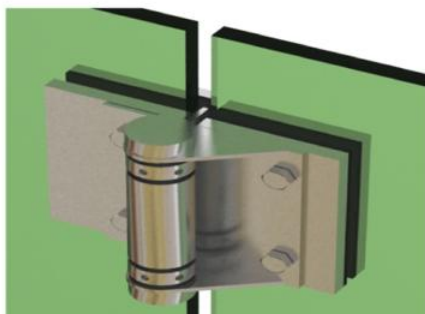

SKYFORCE TOP MOUNT

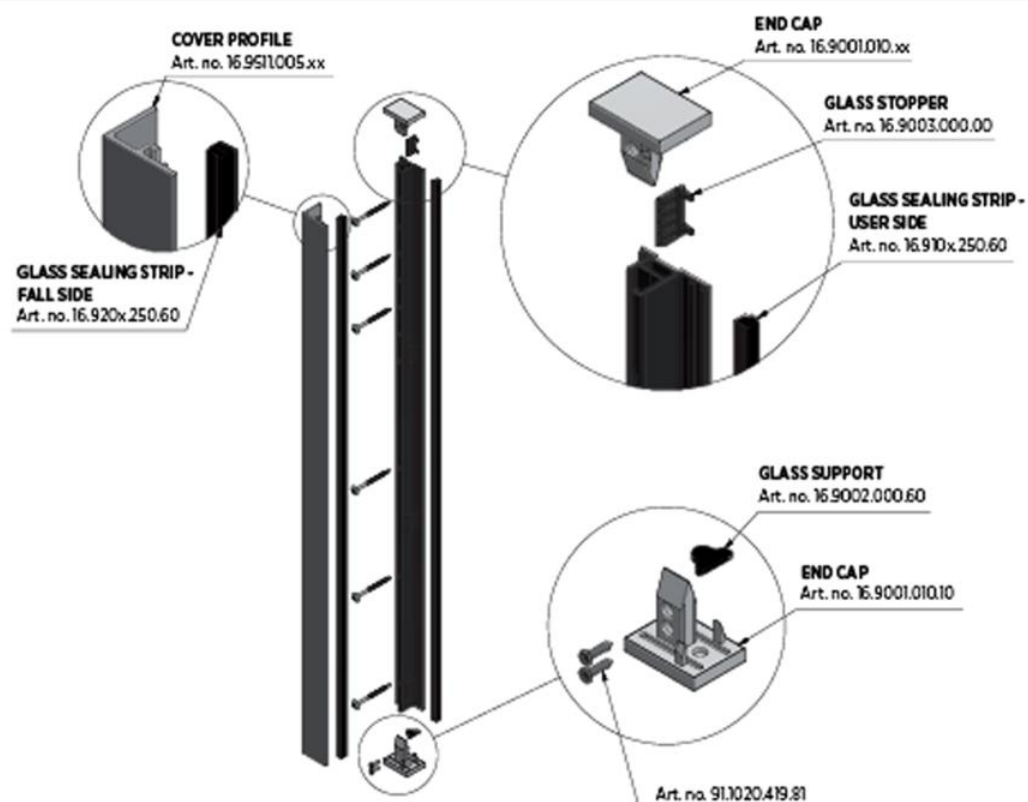

SKYFORCE SIDE MOUNT

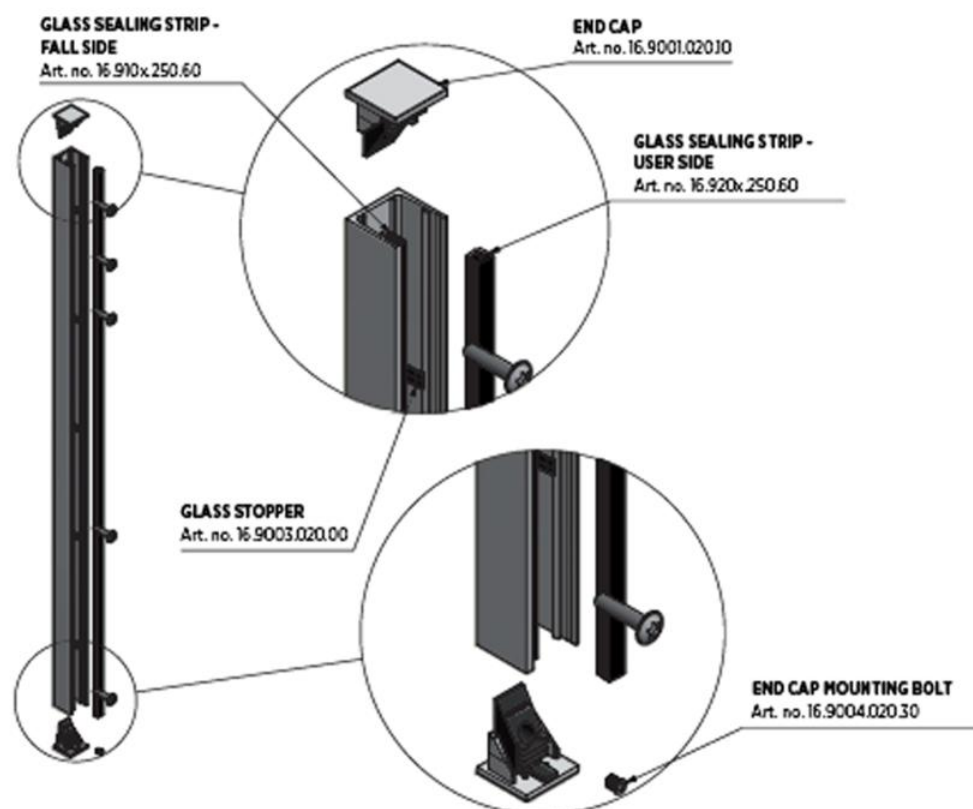

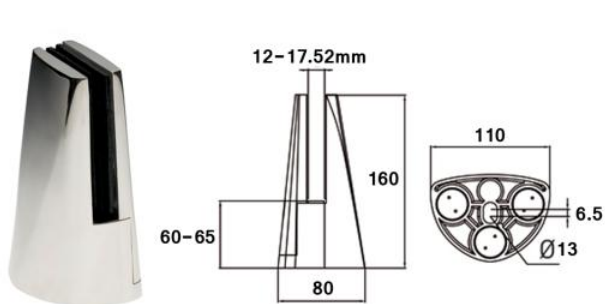

CC-780-BA(Mirror)
CC-780-S(Satin)
Base Spigot - 12, 15 & 17.52mm Glass

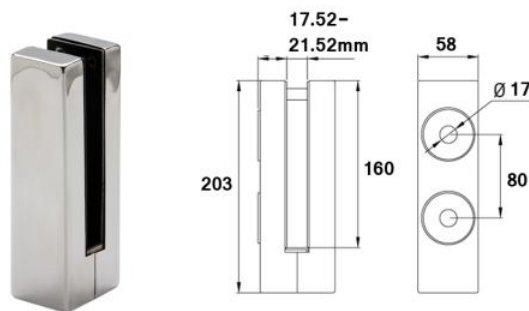

CC-791-BA(Mirror)
Side Fix Spigot
17.52 & 21.52mm Glass



BR-2031
(Face-Fixing Spanner)



CC-772-BA(Mirror)
CC-772-S(Satin)
Adjustable Glass Stand-Off (Square)

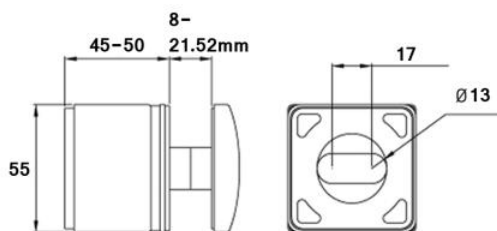

CC-775-050-BA(Mirror)
CC-775-050-S(Satin)
Adjustable Glass Stand-Off (Round)

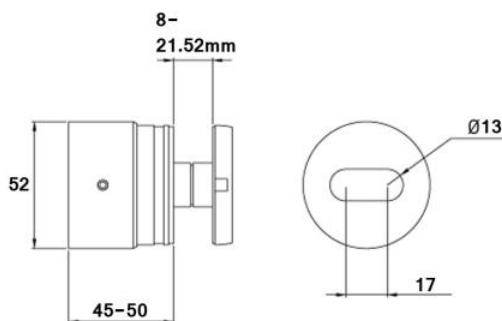

BT-2030 (C-Spanner)



KLH21.5MM-180DEG
Satin
15-21.52mm Glass
0.25kg

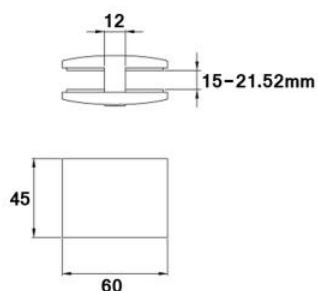

KLH21.5MM-90DEG
Satin
15-21.52mm Glass
0.25kg

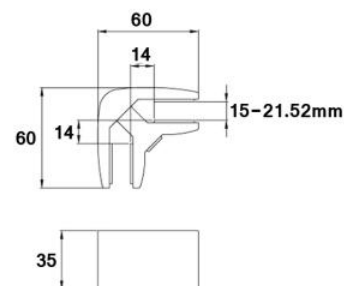



SB-01 (0.74kN/m)
SB-02 (1.5kN/m)
SB-03 (3kN/m)



SB-A1 (0.74kN/m)
SB-A2 (1.5kN/m)
SB-A3 (3kN/m)



SB-0.5S (0.36kN/m)
SB-01S (0.74kN/m)
SB-02S (1.5kN/m)



SB-A1S (0.74kN/m)
SB-A2S (1.5kN/m)



SB-0XS
(Parapet Wall System)

Kensington
Balustrade Systems



Full brochure available detailing; Test Reports, BIM Details, Detailed Drawings, and Installation Instructions

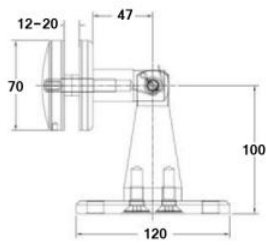

VDH1001-1
Wall to Glass
304/316

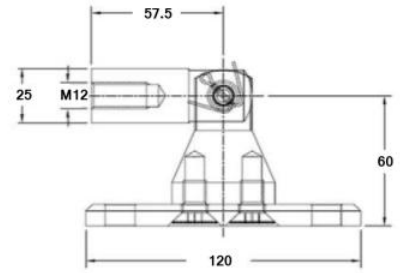

VDH1002-1
Wall to Rod
304/316

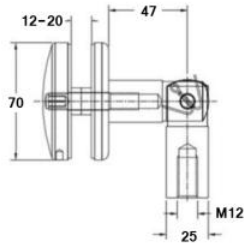

VDH1003-1
Rod to Glass
304/316

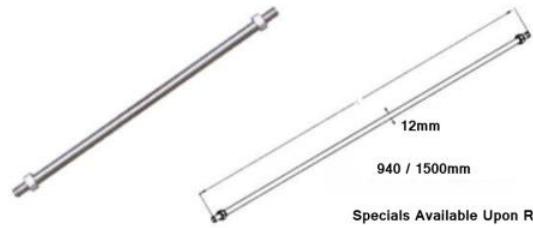

ZUG1001
12mm Threaded Bar - 940 or 1500mm Standard
304/316

Specials Available Upon Request

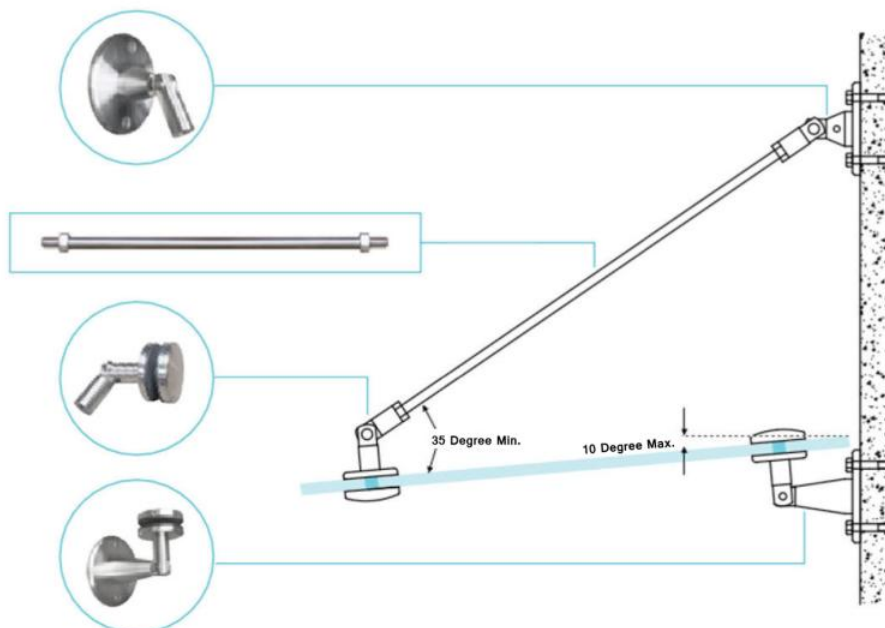
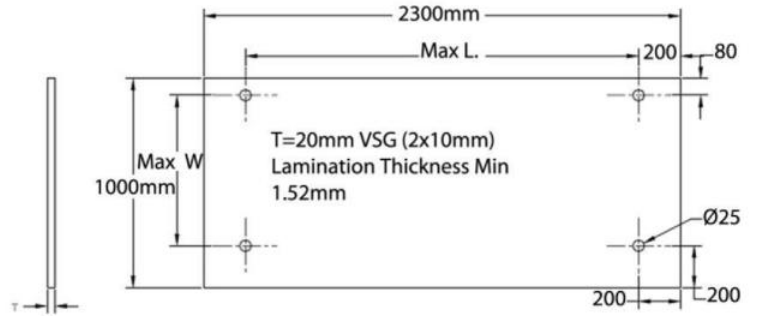
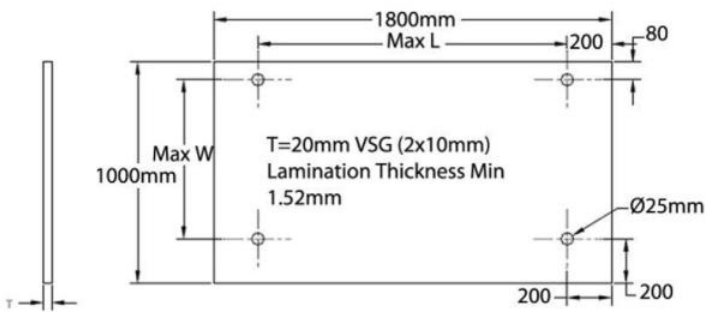

GS/14PR-R3-M12-SET
For 12.76mm Glass Only

	AISI316 satin A14/PR70x40-M12							
	Dimensions mm	M	L	h	a	b	c	d
		12	70-76	60	70	40	48	20

	AISI316 satin A14/PR70x40-60							
	Dimensions mm	∅ D1	h	L	a	b	c	d
		58	50	70-76	70	40	48	20

	AISI316 satin A14/PR-60-M12				
	Dimensions mm	∅ D1	M	h	L
		60	12	50	60

	AISI316 satin A14/PR12-1000-M12			
	Dimensions mm	M	L	∅ d
		12	1000	12

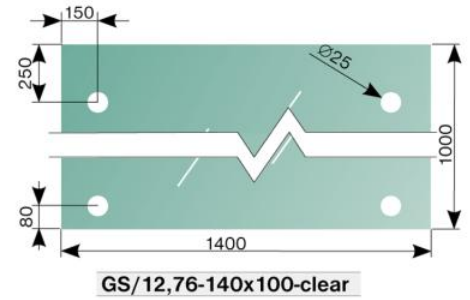

Kit Code: GS14/PR-R3-M12-SE



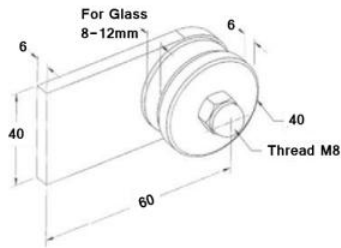

**GLH1020-40 - 320 Satin
(Short Single) - 316**

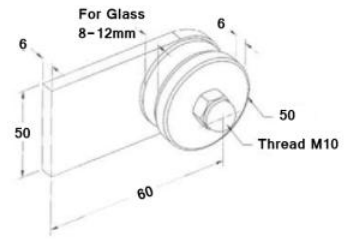

**GLH1020-50 - 320 Satin
(Short Single) - 316**

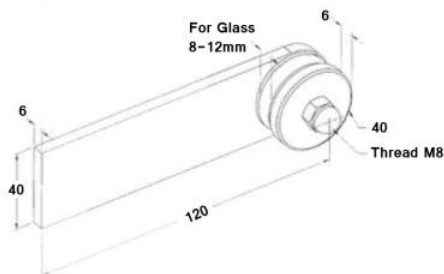

**GLH1021-40 - 320 Satin
(Long Single) - 316**

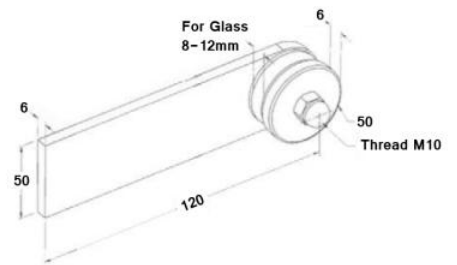

**GLH1021-50 - 320 Satin
(Long Single) - 316**

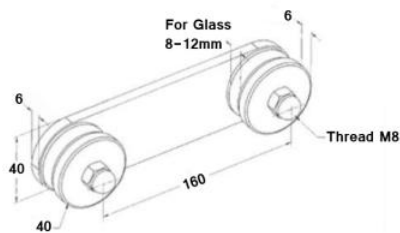

**GLH1022-40 - 320 Satin
(Straight Double) - 316**

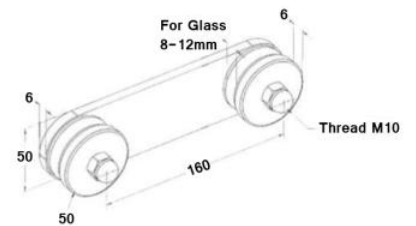

**GLH1022-50 - 320 Satin
(Straight Double) - 316**

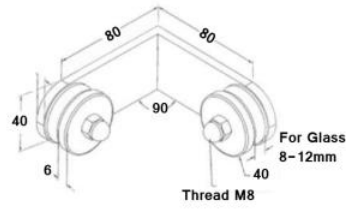

GLH1023-40 - 320 Satin
(Internal Corner) 316

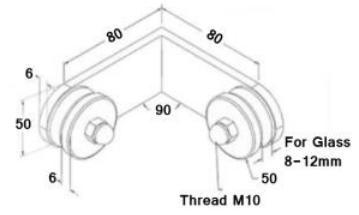

GLH1023-50 - 320 Satin
(Internal Corner) 316

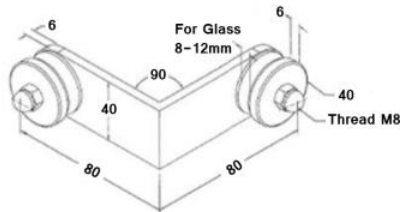
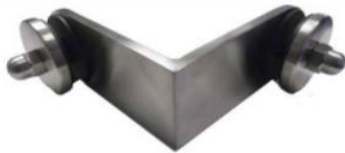

GLH1024-40 - 320 Satin
(External Corner) - 316

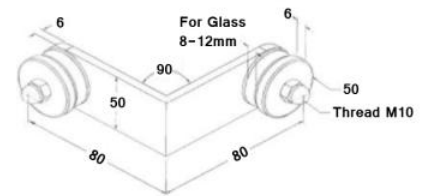

GLH1024-50 - 320 Satin
(External Corner) - 316



Reverse View





8mm-Shower-Profile
 3m Lengths - 8mm Glass
 Ali - Satin Anodised
 (Also available in 304G Mirror polish)



10mm-Shower-Profile
 3m Lengths - 10mm Glass
 Ali - Satin Anodised
 (Also available in 304G Mirror polish)

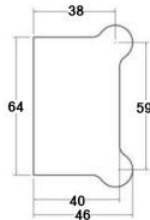
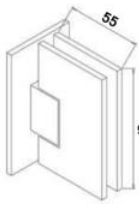

KT-SSH-101-S4 / KT-SSH-101-(04)M
 Glass to Wall Hinge
 304G Satin / 304G Mirror

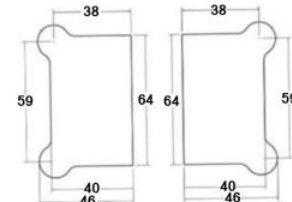

KT-SSH-102-S4 / KT-SSH-102-(04)M
 Glass Door to Fixed Glass Hinge
 304G Satin / 304G Mirror

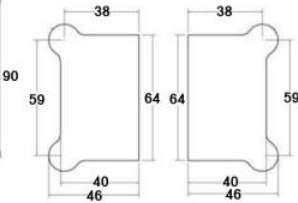

KT-SSH-103-S4 / KT-SSH-103-(04)M
 Glass Door to Fixed Glass Hinge 135D
 304G Satin / 304G Mirror

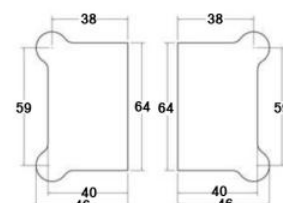
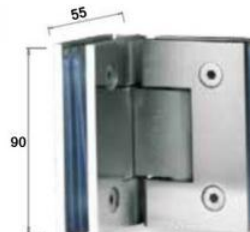

KT-SSH-104-S4 / KT-SSH-104-(04)M
 Glass Door to Fixed Glass Hinge 90D
 304G Satin / 304G Mirror

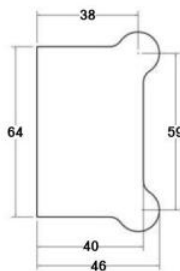

KT-SSH-105-S4 / KT-SSH-105-(04)M
 Fixed Glass to Wall Hinge 90D
 304G Satin / 304G Mirror

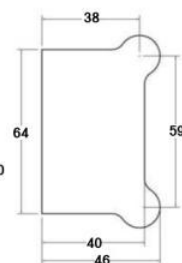
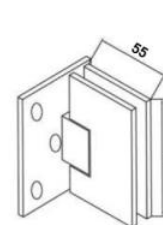

KT-SSH-106-S4 / KT-SSH-106-(04)M
 Glass Door to Wall Hinge
 304G Satin / 304G Mirror

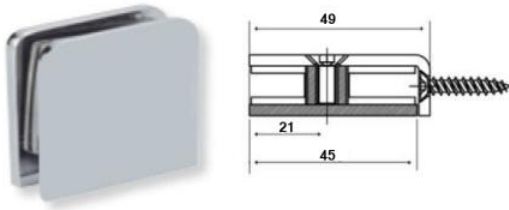

KT-SGC-201-S4 / KT-SGC-201-(04)M
Glass Panel to Wall Connector
304G Satin / 304G Mirror

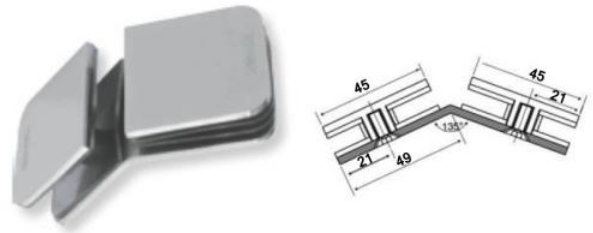

KT-SGC-202-S4 / KT-SGC-202-(04)M
Glass to Glass Connector 135D
304G Satin / 304G Mirror

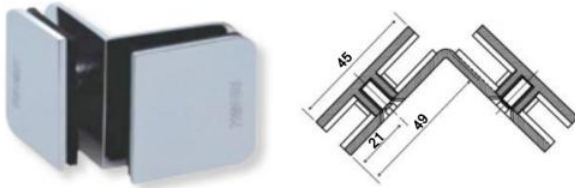

KT-SGC-203-S4 / KT-SGC-203-(04)M
Glass to Glass Connector 90D
304G Satin / 304G Mirror

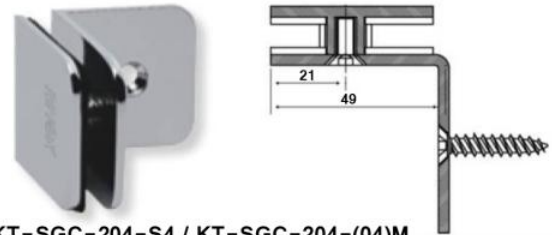

KT-SGC-204-S4 / KT-SGC-204-(04)M
Wall to Glass Connector 90D
304G Satin / 304G Mirror

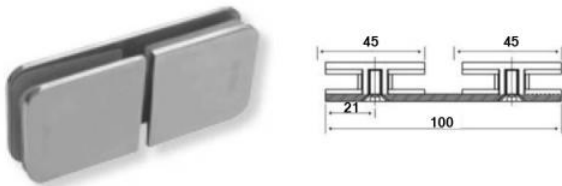

KT-SGC-205-S4-S / KT-SGC-205-(04)M
180D Glass to Glass Connector
304G Satin / 304G Mirror

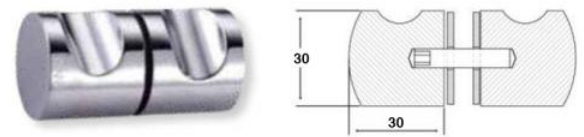

KT-NOB-101(04)M
Glass Door Nob 30 x 30mm
304G Mirror

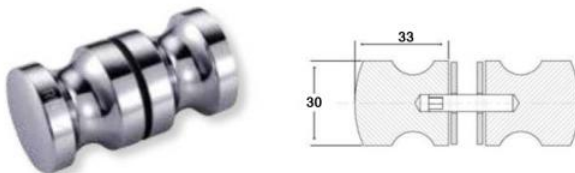

KT-NOB-102(04)M
Glass Door Nob 30 x 33mm
304G Mirror

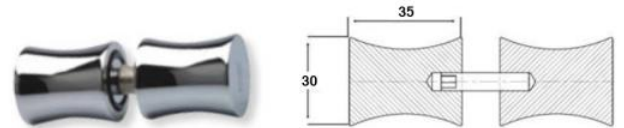

KT-NOB-103(04)M
Glass Door Nob 30 x 35mm
304G Mirror

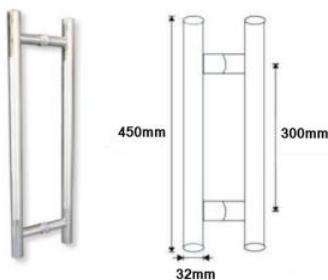

KT-HDH-306(04)S
Handle for Glass Door
304G Satin



KT-TDH-201(04)M
Handle/Towel Bar
304G Mirror

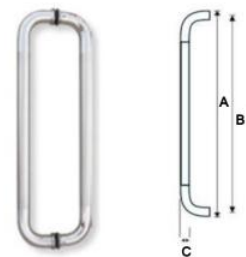

KT-DDH-301-(04)S
Handle for Glass Door
304G Satin

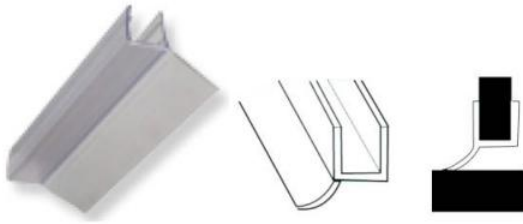

KT-SPS-101-8MM / KT-SPS-101-10MM
Plastic Seal for 8/10mm Glass

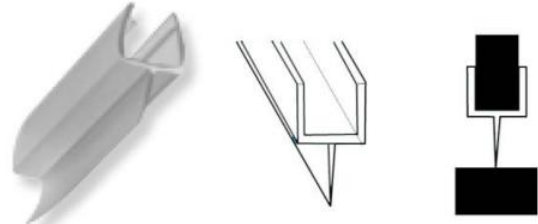

KT-SPS-102-8MM / KT-SPS-102-10MM
Plastic Seal for 8/10mm Glass

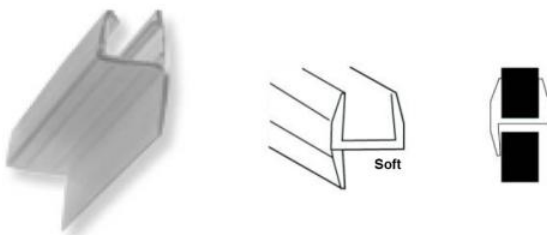

KT-SPS-103-8MM / KT-SPS-103-10MM
Plastic Seal for 8/10mm Glass

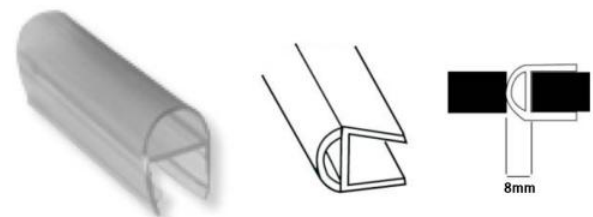

KT-SPS-104-8MM / KT-SPS-104-10MM
Plastic Seal for 8/10mm Glass

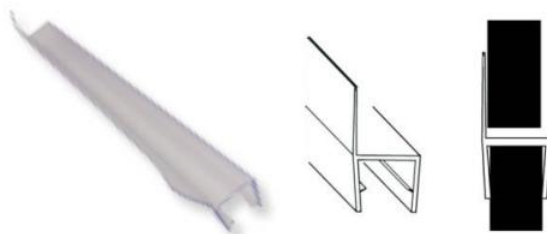

KT-SPS-105-8MM / KT-SPS-105-10MM
Side Seal with Wing 17mm for 8/10mm Glass



KT-SPS-106-8MM / KT-SPS-106-10MM
Side Seal with Wing 18mm for 8/10mm Glass

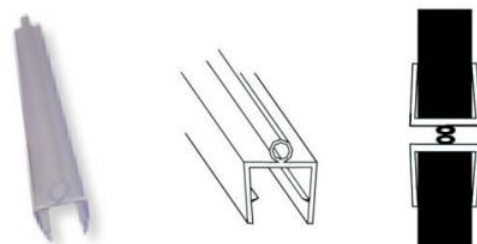

KT-SPS-107-8MM / KT-SPS-107-10MM
Anti Collision Ring for 8/10mm Glass

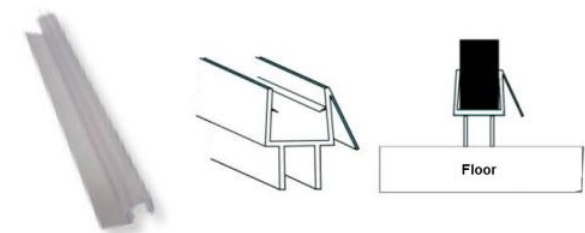

KT-SPS-108-8MM / KT-SPS-108-10MM
Water Dispersal Seal for 8/10mm Glass

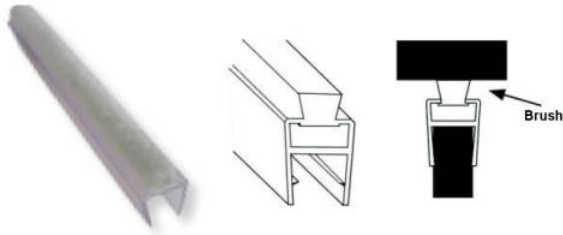

KT-SPS-109-8MM / KT-SPS-109-10MM
 Plastic Seal for Sliding Doors with Brush 8x8
 For 8/10mm Glass

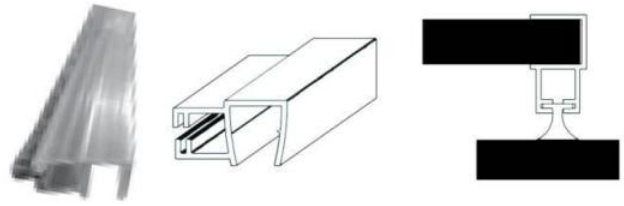

KT-SPS-110-8MM / KT-SPS-110-10MM
 Plastic Seal for Sliding Doors with Brush 7x8
 For 8/10mm Glass

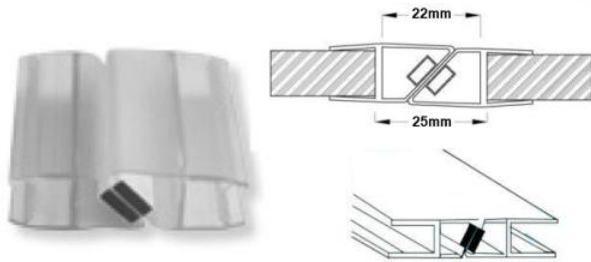

KT-MPS-101-8MM / KT-MPS-101-10MM
 Magnetic Plastic Seal for Sliding Glass Door at 180D
 For 8/10mm Glass

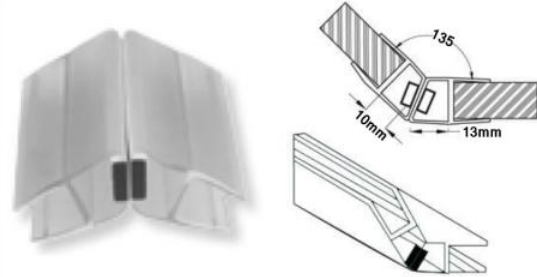

KT-MPS-102-8MM / KT-MPS-102-10MM
 Magnetic Plastic Seal for Sliding Glass Door at 135D
 For 8/10mm Glass

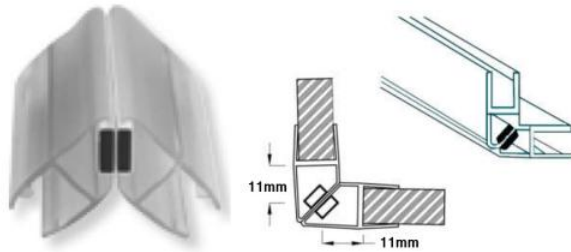

KT-MPS-103-8MM / KT-MPS-103-10MM
 Magnetic Plastic Seal for Sliding Glass Door at 90D
 For 8/10mm Glass



Saddles sold separately,
available in 60.3, 50.8/
48.3 and 42.4mm

HH1003Y - 75mm Offset - 304/316
HH1003K - 90mm Offset - 304/316



HH1012K
Adjustable Handrail Bracket
304
Saddles sold separately

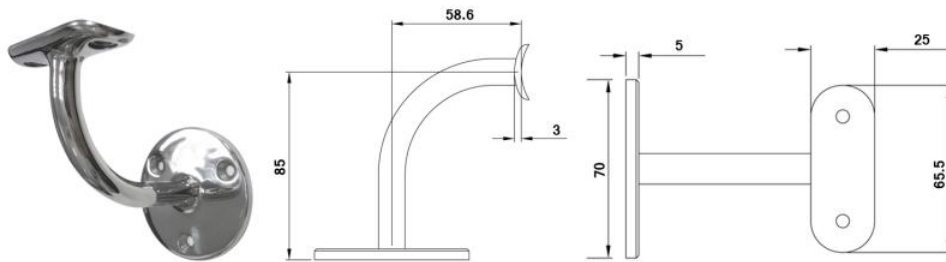

WS172 - 85mm Offset - 316 (Satin)

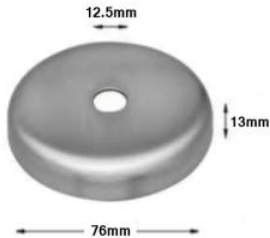

ROS1003-12.5K
76mm Cover Plate
With 12.5mm Hole
304/316

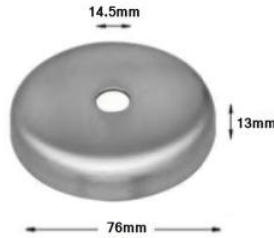

ROS1003-14.5K
76mm Cover Plate
With 14.5mm Hole
304/316



HH1002K-H-14MM
Straight Stem M8
304/316



HH1002-50.8-304
Straight Stem M16
304

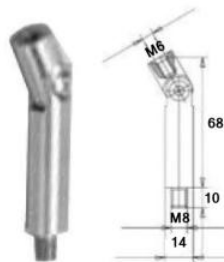

GLS1002K
Adjustable Neck M8
304/316



GLS1002-M16-304
Adjustable Neck M16
304

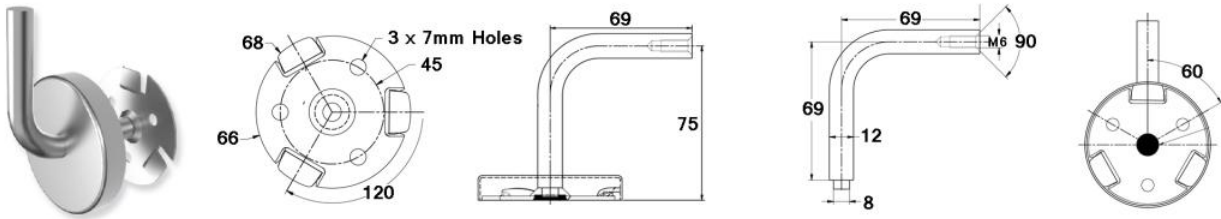

KT-Twist-Lock-75mm
75mm Off-Set Twist
and Lock Handrail
Bracket
 304 and 316G - Satin

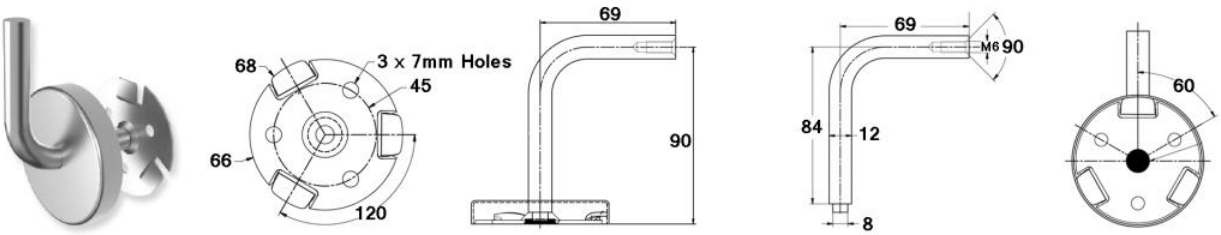

KT-Twist-Lock-90mm
90mm Off-Set Twist
and Lock Handrail
Bracket
 304 and 316G - Satin

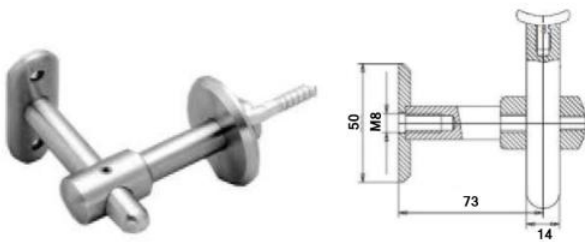

HH1004
Handrail Bracket
 304

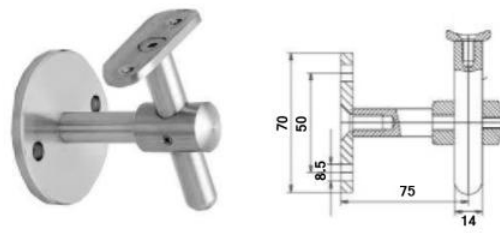

HH1006
Wall Mounting Bracket
 304

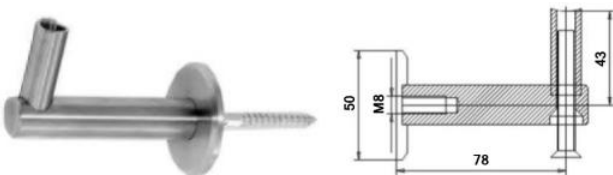

HH1007
Handrail Fixing Bracket
 304

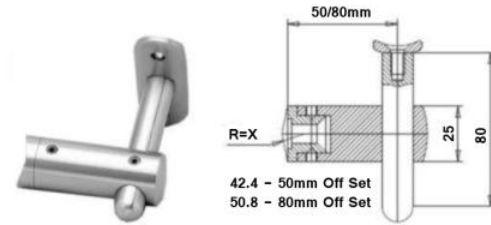

HH1010
Handrail Support
 304

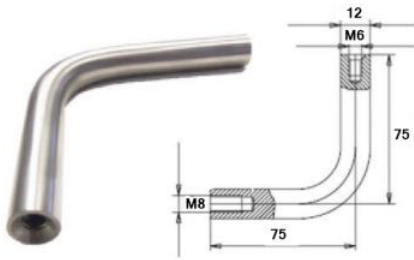

HH1003-STEM12K
Arm Only
304

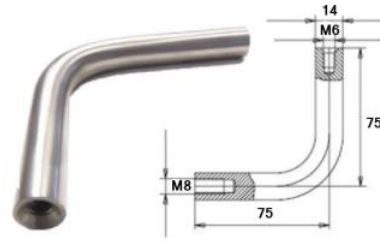

HH1003-STEM-14MM
Arm Only
304/316

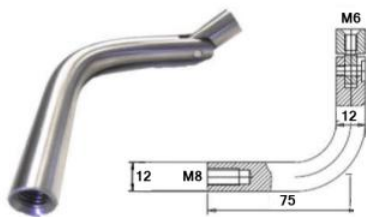

HH1003-STEM-ADJ-12MM
Arm Only
304/316

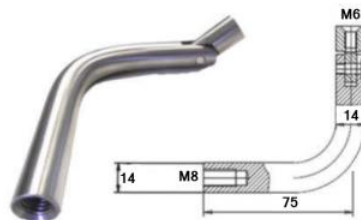

HH1003-ADJ-14MM
Arm Only
304/316

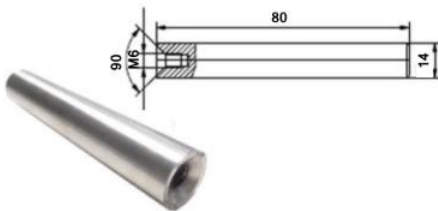

HH1002-H-ROUND-K
Rounded End Stem
304

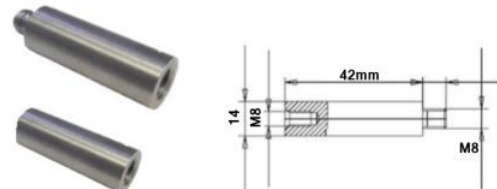

HH1002-H-M8/M8 - 42mm Stem Extension
HH1002-H-M8/M6 - 42mm Stem Extension
304



HH1003-M8/Blank
75 or 90mm Offset x 75mm High
14mm 90 Degree Stem
M8 Internal, other end blank
316 Satin

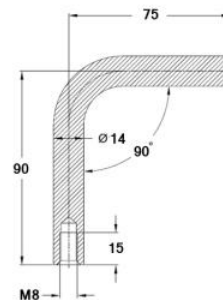
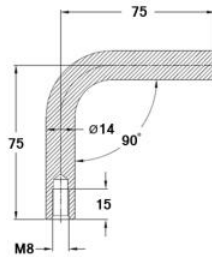

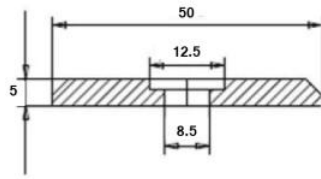

RON1006-50-12.5K
8.5mm Hole 12.5mm Recess
304/316

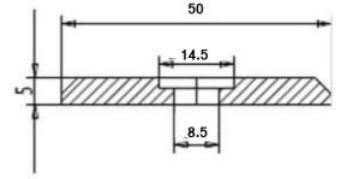
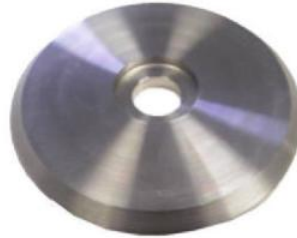

RON1006-50-14.5K
8.5mm Hole 14.5mm Recess
304/316

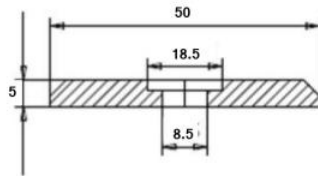
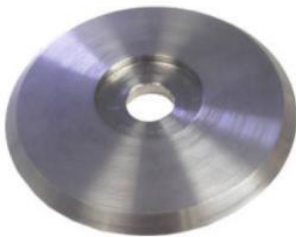

RON1006-50-18.5K
8.5mm Hole and 18.5mm Recess
304/316

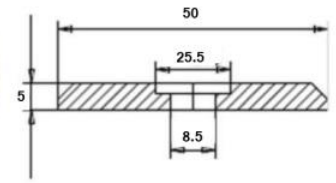

RON1006-50-25.5K
8.5mm Hole and 25.5mm Recess
304/316

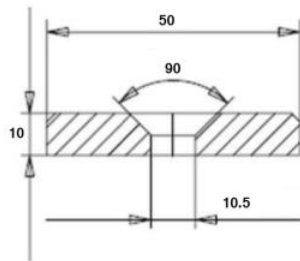
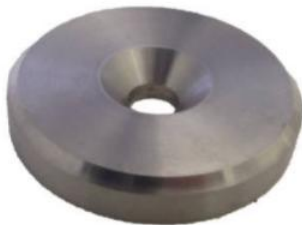

RON1008-50K
50mm Plate 10.5mm CSK
304/316

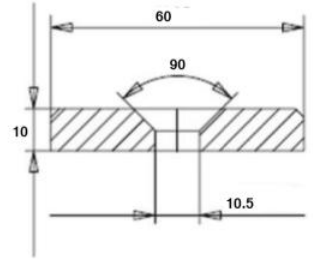

RON1008-60K
60mm Plate 10.5mm CSK
304/316

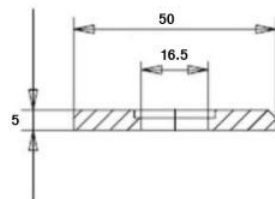

RON1005-50-K
50mm Plate 16.5mm Recess
304

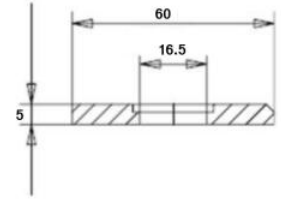

RON1005-60K
60mm Plate 16.5mm Recess
304/316

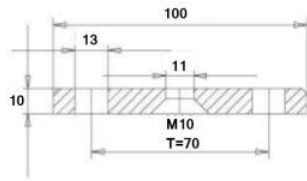

RON1001K-100-M10
M10 x 100 x 2 Holes
304/316

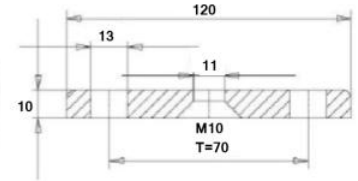

RON1001K-120-M10
M10 x 120 x 2 Holes
304/316

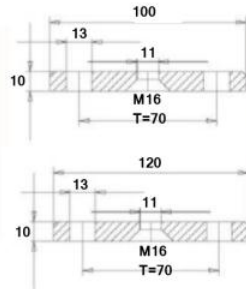

RON1001K-100-M16 - M16 x 100 x 2 Holes
RON1001K-120-M16 - M16 x 120 x 2 Holes
304/316

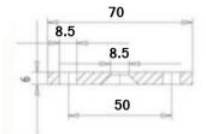

Plain Holes

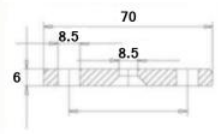

Countersunk Holes

RON1004K
70 x 6mm Plate
2 x 8.5mm Holes
304/316

RON1004-3HOLE
70 x 6mm Plate
2 x 8.5mm Holes
304/316

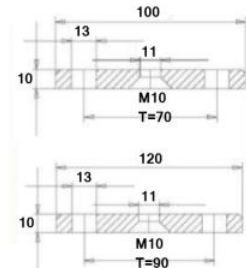

RON1002K-100-M10 - M10 x 100 x 3 Holes
RON1002K-120-M10 - M10 x 120 x 3 Holes
304/316

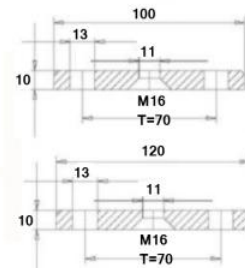

RON1002K-100-M16 - M16 x 100 x 3 Holes
RON1002K-120-M16 - M16 x 120 x 3 Holes
304/316

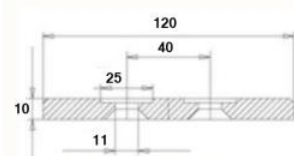

RON1003-120-M16
12 22 02 - 120mm Wall Plate
304/316

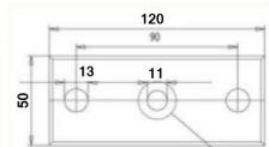

RON1007K
M10 - 120 x 50mm / M16 - 140 x 60mm
304/316

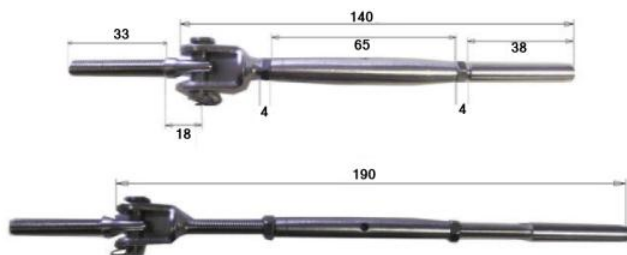

SHA1030-316
Adjustable End Terminal for Crimping 5mm Wire
316



EST1001-316-B-K
End Wire Holder for Crimping 5mm Wire
316



SHA1020-WIREHOLDER
Wire Holder x 5mm Wire, with 3 Grub Screws
304

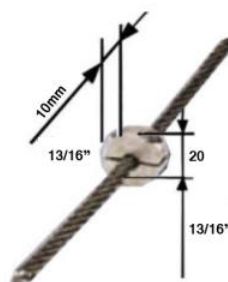

W05 / W095
For 5mm Wire
304/316

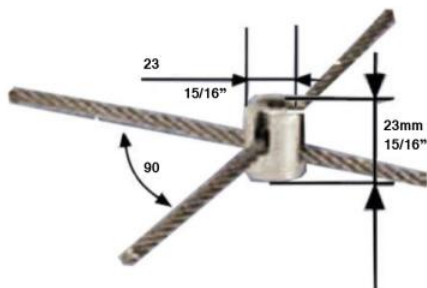

WX5 / WX95
Cross Wire Holder for 5mm Wire
304/316



STH2001-6.3
5mm Wire Retainer for 42/48/Flat
304/316



SHA1005
5mm Wire Eye Bolt
316



SHA1020
5mm Wire Holder for 42/48/Flat



WB-805-316
5mm Wire - 1 x19mm 50m / 100m / 250m Coils
316



Crimper
Hydraulic Battery Crimping Tool
(Available for Rent)



Wire Cutters

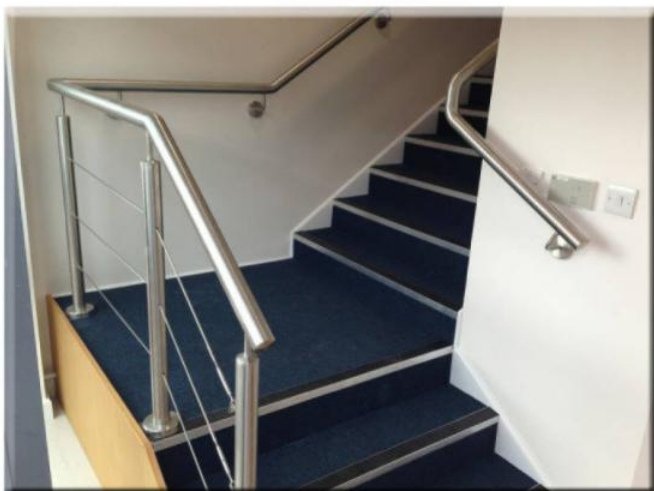

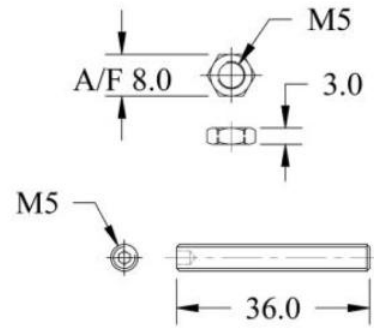
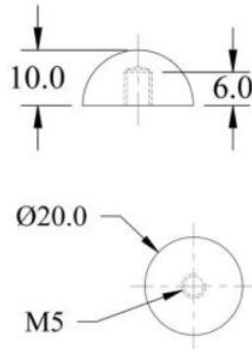
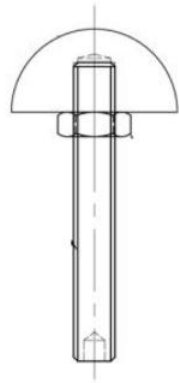

SKT/BD-1 £3.95

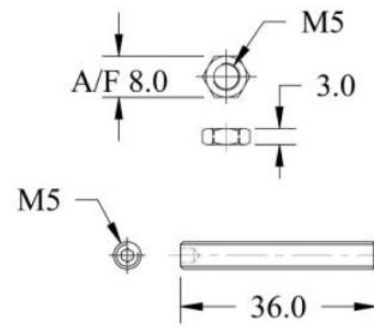
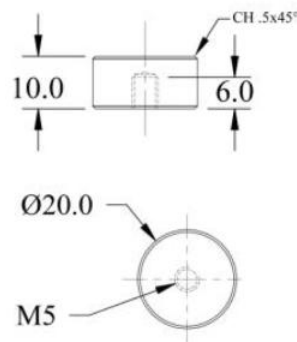
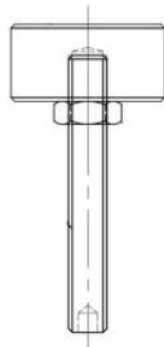

SKT/BD-2 £3.95

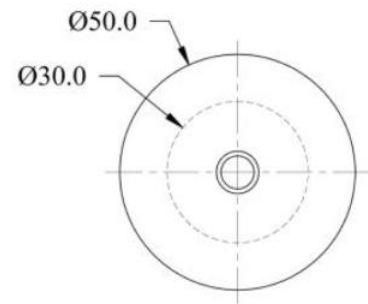
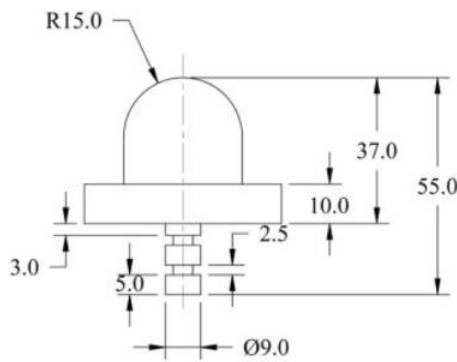

SKT/BD-3 £9.95

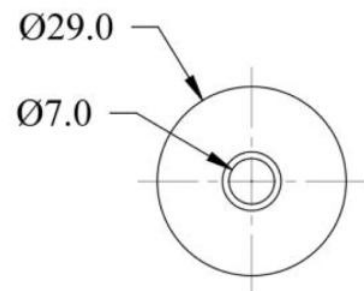
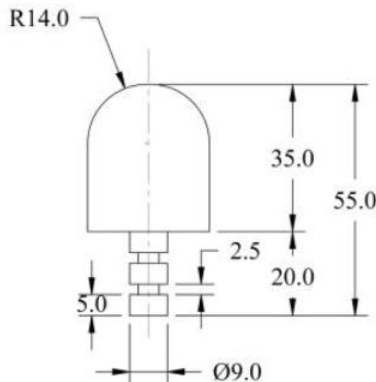

SKT/BD-4 £6.95



SKT/BD-5 £9.95

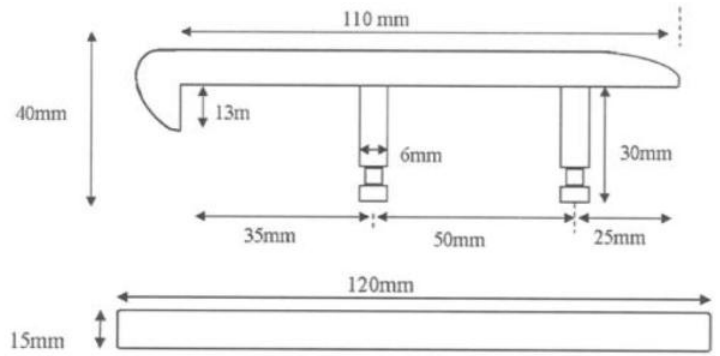

SKT/BD-6 £9.95

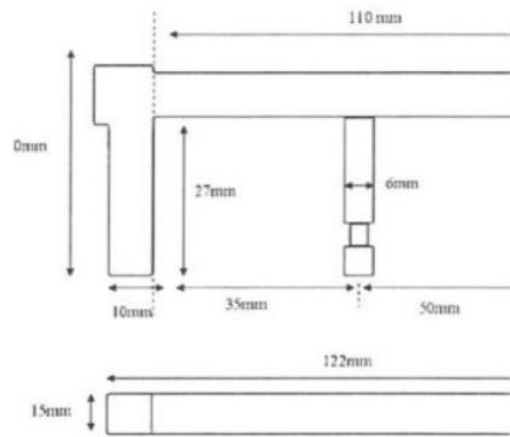

SKT/BD-7 £6.95

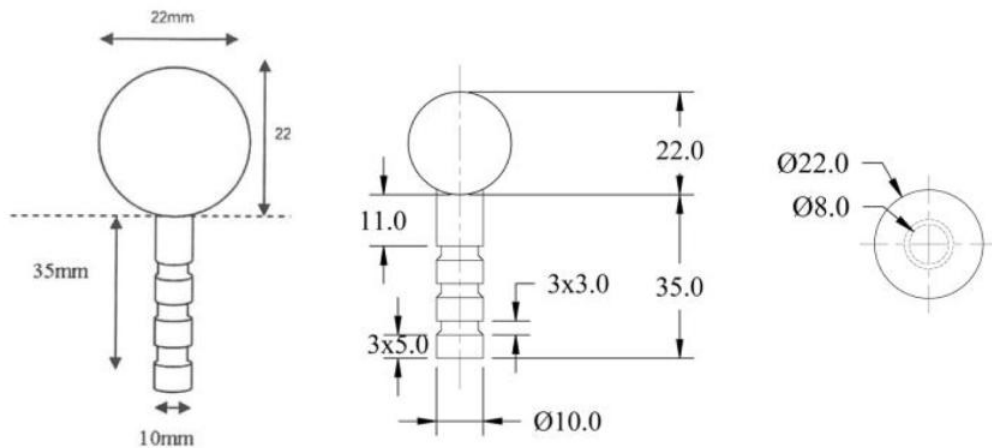

SKT/BD-8 £7.95

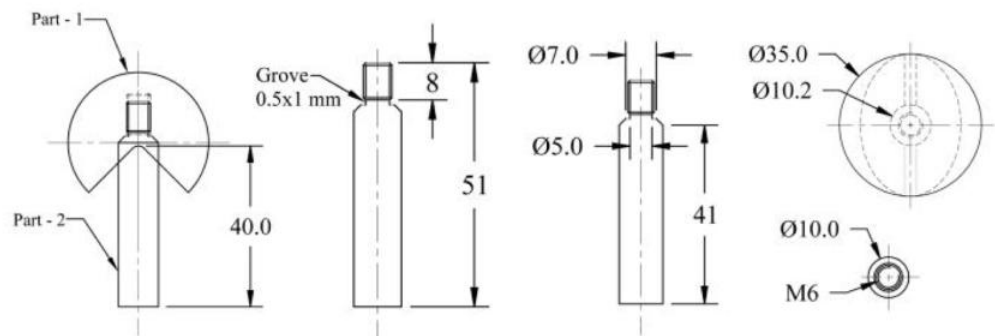

SB-LED Range

Suitable with Glass Balustrade (Post + Rail) and Grab Rails



<https://www.sb-railing.co.uk/en/producten/sb-led-system.html>



KLE1 - Glue Gun



**3430-Epoxy / E205-Epoxy
50ml Toughening Adhesive
(Ideal For Gaps Over 1mm)**



**KLE6B - Nozzles
(1 Nozzle Supplied With Each
3430 / E205)**



**6740.01 - SB Cleaner
500ml Stain Remover**



**6740.02-SB Super Cleaner
100ml x 2 Conditioner &
Rust Remover**



**6740.03 - SB Glue
(Ideal For Small Gaps
Under 1mm)**



**6740.04 - Activator Spray
150ml Faster Fixation**



**6740.05 - Cleaner
Degrease and Clean 400ml**



**6740.06-Screw Retention
Thread Locking Paste 50ml**



**PSP1001
Preservation Spray (Care Oil)**



**RSP1001
Cleaning Spray**



**VL1001
Cleaning Pad**

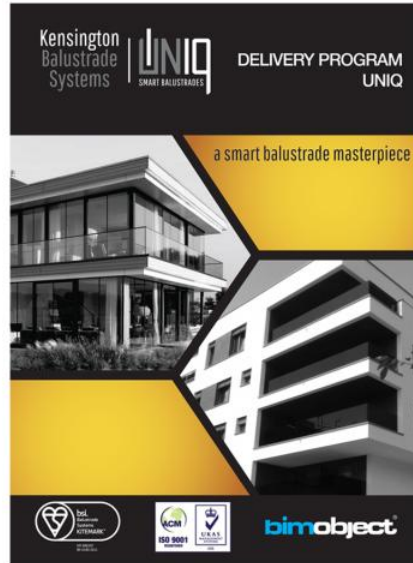

For copies of our brochures, or for any enquiries, please email: sales@kensingtonforge.co.uk or call us on 01582 563794

For a more extensive range of 42.4 and 48.3mm, with a 2mm wall thickness; see www.sb-railing.co.uk

KENSINGTON BALUSTRADE SYSTEMS

Copyright @ Kensington Traders Limited 2021

Kensington Traders Limited
23-25 Ribocon Way, Progress Park
Luton, Bedfordshire, LU4 9UR

T: 01582 563 794

F: 01582 491 925

E: Sales@kensingtonforge.co.uk

W: www.balustrade-systems.com



BRITISH STAINLESS
STEEL ASSOCIATION